



**ANCERA  
CARGO**  
CONSUMER / INDUSTRIAL

Leader in Heavy Duty Cargo Securement



*“Committed to Quality, Innovation  
& Customer Service”*



State-of-the-art Quality Testing Lab & Engineering Center with CAD capability, 3-D Printer & Plasma Cutting Table for precision modeling

160,000 sq. ft. dedicated to fabrication, sewing, assembly & distribution in Kentucky & Texas



Check out our YouTube Channel for dozens of videos on how not only use, but get the most out of, your cargo control products.



40,000 sq. ft. of office space including a Professional Video Studio with chroma green screen wall



## BUNGEE CORDS & TARP TIES

Bungee Cords .....	4
Tarp Ties .....	6

## SLINGS & RECOVERY STRAPS

Slings .....	8
Vehicle Recovery Straps .....	10

## CABLE PULLERS

Cable Pullers .....	12
---------------------	----

## TIE-DOWNS

Industrial .....	14
Commercial .....	16
Consumer .....	18
Vehicle Transport .....	20
Motorsports .....	22

## TRANSPORT CHAIN & BINDERS

Chain Assemblies (Transport) .....	24
Chain Hardware .....	25
Chain Binders .....	26

## HEAVY DUTY

Corner Protectors .....	28
Winch Straps .....	29
Winch Strap Accessories .....	30
Winches .....	32
Winch Track .....	34
Winch Bars .....	35
Accessories .....	35
Logistic Straps .....	36
Logistic Track .....	36
Cargo & Jack Bars .....	37
Driver Assist Products .....	37
Track Fittings & Anchors .....	38
Shackles & Quick Links .....	40

## HOOKS, BUCKLES & WEBBING

Hooks .....	42
Buckles & Webbing .....	44

## SAFETY FLAGS & BANNERS

Flags & Banners .....	48
-----------------------	----

## APPENDIX

Merchandising Support .....	50
Index by Part Number .....	51





---

# CONSUMER/INDUSTRIAL MISSION

---

Welcome to Ancra Cargo's Consumer/Industrial Division! Our mission is to help our customers increase their share of the consumer and commercial cargo control markets and attract new customers through the supply of quality built, reliable and cost-effective products while maintaining the highest regard for meeting industry standards and cargo transportation safety requirements.

---

## ABOUT ANCRA CARGO

---

**CSG**  
Construction Solutions Group ›  
Business Segments:  
• Commercial Construction Solutions  
• Industrial Construction Solutions  
• Construction Equipment

**ASG**  
Applied Solutions Group  
Business Segments:  
• Electronics & Thermal Solutions  
• Cargo Solutions  
• Metal Solutions  
• Recycling Solutions

**MPG**  
Metal Processing Group ›  
Business Segments:  
• Steel Wire Products  
• Steel Fasteners  
• Wire Rod

**ITG**  
Industrial Technologies Group  
Business Segments:  
• Heavy Equipment  
• Water Infrastructure  
• Capital Equipment  
• Specialty Solutions & Components

Ancra Cargo is a full-line manufacturer of cargo control products and related accessories with an emphasis on commercial and heavy-duty fleet transport applications. The Ancra brand name is highly regarded by professionals throughout North America for quality and reliability. Our in-house engineering and experience help ensure that our products comply with current industry standards and federal transportation safety requirements. Ancra is a wholly owned business in the Applied Solutions Group of The Heico Companies, LLC. Heico is a multi-billion-dollar global entity, and through its holdings is the leading supplier of cargo control products in North America serving the Heavy Duty, Military, Aviation, Towing, Auto Transport, Power Sports, DIY Consumer, Commercial and Industrial markets.



Ancra Cargo is a certified Women Owned business by the Women's Business Enterprise National Council. Whether your company is selling to government entities, large corporations who set aside a portion of their spend for minority owned businesses or if you are simply looking to strengthen your own company's commitment to diversity in your community, buying Ancra products can help. To learn more, please contact your Ancra Representative.



# **BUNGEE CORDS & TARP TIES**

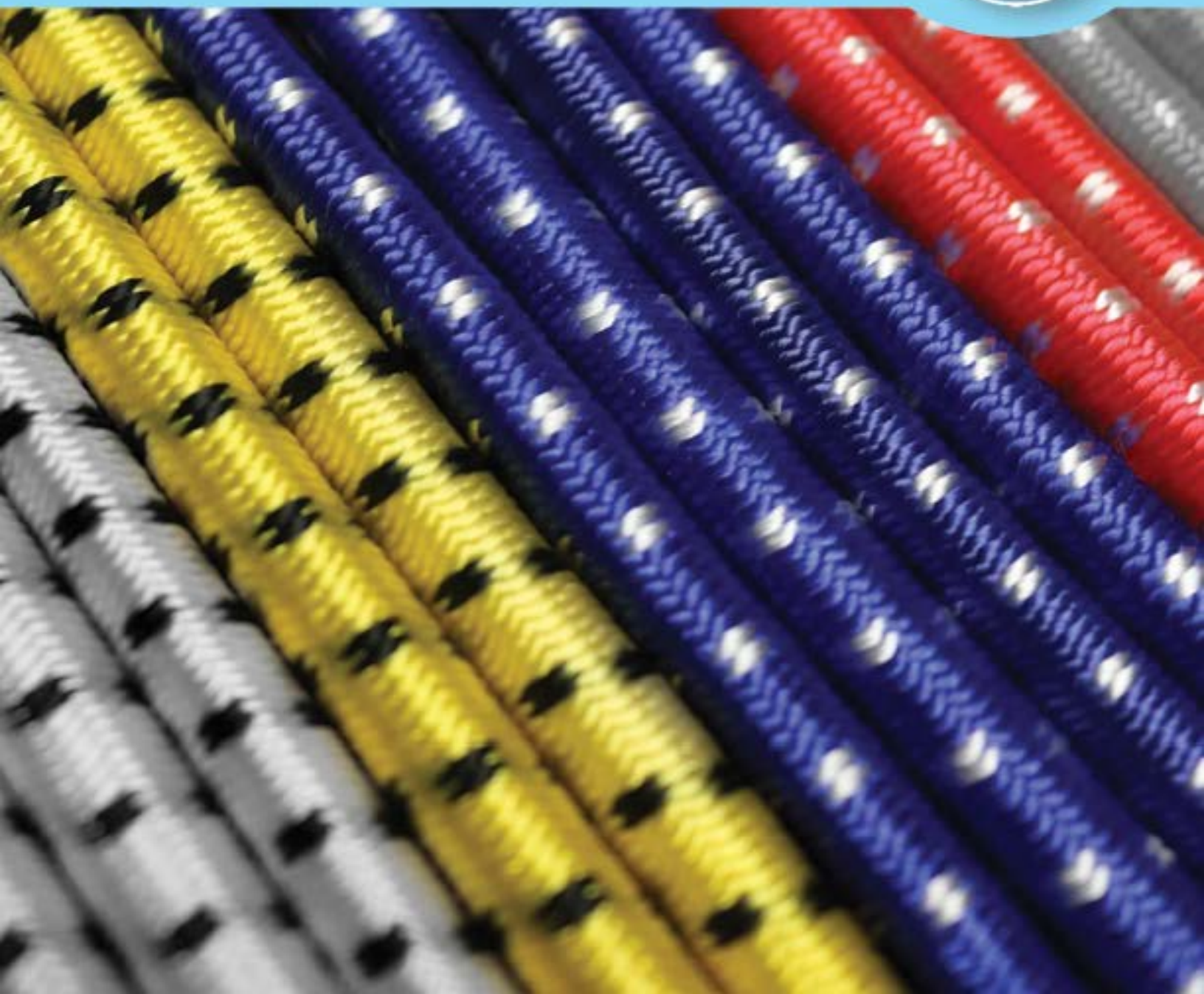



# BUNGEE CORDS

## Bungee Cords

### Standard Duty

- Vinyl coated steel hooks with tip guards
- Strong UV and abrasion resistance
- Stranded first quality latex rubber
- Bulk packaged with UPC tag
- Color coded by length

Part Number	Length (Inches)	Color
95413	13"	Green
95418	18"	Yellow
95424	24"	Blue
95430	30"	Orange
95436	36"	Red

#### 95400 Starter Pack

Contains (10) each of 95413, 95418, 95424, 95430 & 95436



### EZ Grip Series | Clamshell

- PVC injection molded grip steel hooks
- Stranded first quality latex rubber
- Strong UV & abrasion resistance
- Clamshell packaging
- Color coded by length



Part Number	Length (Inches)	Color
95518-1	18"	Yellow
95524-1	24"	Blue
95536-1	36"	Red
95540-1	40"	Green
95548-1	48"	Orange

#### 95500-1 Starter Pack

Contains (6) each of 95518-1, 95524-1, 95536-1, 95540-1 & 95548-1



### Heavy Duty

- 50% More rubber than standard cords
- HD steel hooks w/corrosion resistant coating & tip guards
- Stranded first quality latex rubber
- Safety orange polyester outer jacket, all lengths
- Bulk packaged with UPC tag

Part Number	Length (Inches)
95618	18"
95624	24"
95632	32"
95640	40"
95648	48"

#### 95600 Starter Pack - Bulk

Contains (10) each of 95618, 95624, 95632, 95640 & 95648



### SL148 | Carrabungee™ Cord

- "Build-a-Net" technology
- Link multiple cords together
- 24" Length
- Carabiner hooks
- Polyester jacket



### XB210-22P | 10<sup>N</sup> Mini Cords 22 Piece

Great for bundling and storing tools, cords, blueprints, camping equipment, household items and much more!



### SL33 | 10<sup>N</sup> Mini Cords 4 Piece

Great for bundling and storing tools, cords, blueprints, camping equipment, household items and much more!



## Tarp & Canopy Ties

### SL43 | 10 Piece

- For use with tarps and canopies
- 10 Piece
- Length: 10"





# BUNGEE CORDS

## Bungee Nets

### 95480 Bungee Net with Detachable Hooks

- Great for securing tarps and keeping light cargo and debris from moving around
- Smaller 5" x 5" cross pattern design for greater load coverage
- One size fits most trucks & SUV's
- Minimum size: 48" x 72"
- Maximum stretch: 72" x 108"
- Includes storage bag
- 16 Hooks are detachable

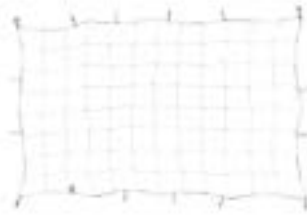

### SL50 36" 6 Arm Bungee Net

- 6 Attachment points
- Center ring gives infinite shape options
- Great for larger, bulky items



## Bungee Cord - Assortments

### SL69 6 Piece

- Heavy duty cord
- Polybagged
- Safety orange style



Contains:  
(2) - 24"  
(2) - 32"  
(2) - 40"

### SL41 12 Piece

- Standard cord
- Polybagged
- Multi-colored style



Contains:  
(4) - 18"  
(2) - 24"  
(1) - 30"  
(1) - 36"  
(4) - 10" mini

### SL64 18 Piece

- Standard cord
- Polybagged
- Yellow-jacket style



Contains:  
(4) - 16"  
(4) - 18"  
(4) - 24"  
(2) - 30"  
(4) - 10" mini

### SL42 20 Piece

- Standard cord
- Multi-colored



Contains:  
(4) - 12"  
(2) - 18"  
(2) - 24"  
(1) - 32"  
(6) - canopy  
(5) - 10" mini

## Rubber Tarp-Ties & Rubber Rope

### SL58 10 Piece Assortment



Contains:  
(4) - 14"  
(2) - 19"  
(2) - 24"  
(2) - 35"

(Hook to Hook Measurement)

### 49454 Rubber Rope Reel

- Solid core rubber
- 150' Coils
- Bulk non-packaged

Part Number	Size (Inches)
49454-11	3/8"
49454-13	7/16"



### 49211-10 Rubber Rope Hook

- Steel wire with twisted loop
- Bulk 100 per pack



# TARP TIES

## Commercial Grade

### 95800 Series | EPDM Tarp Ties

- Proprietary blend of EPDM with excellent UV properties to resist cracking and extend strap life
- Strong stretch and recovery performance in both hot and cold temperatures
- ½ Inch thick, teardrop ends to help prevent hooks from tearing through strap
- Zinc plated, rust-resistant steel S-hooks
- Color coded, tri-lingual, UPC coded labels applied directly to each strap
- Bulk packaged with UPC
- Retail pack 1

Part Number	Trade Size (Inches)	Length w/Hooks (Inches)
95810	10"	14"
95815	15"	19"
95821	21"	24"
95831	31"	35"
95841	41"	45"

**Economically designed for strong Year-Round Performance**

### 95800 | EPDM Tarp Tie Starter Pack

Contains (10) each of 95810, 95815, 95821, 95831 & 95841

### 95828 | Adjustable EPDM Tarp Tie

- 28" Long with reinforced holes every 4 inches which allows adjusting to different lengths



## Heavy Duty / Fleet Grade

### GOLDLINE® EPDM Tarp Ties

- 100% EPDM
- Longer lasting
- Molded EPDM construction for high ozone resistance and strength
- Resiliency of molded natural rubber for good cold weather stretch properties

NOTE: Sold by the box of 50 tarp ties. Individual straps are not UPC coded.  
Order quantity of 1 = 50 tarp ties conveniently packed in polybags of 10 each.

Made in USA 

**Superior strength & durability, especially in extreme heat environments**



Part Number	Trade Size (Inches)	Length w/Hooks (Inches)
52210GL	10"	14"
52215GL	15"	19"
52221GL	21"	25"
52231GL	31"	35"
52241GL	41"	45"

### Natural Rubber Tarp Ties

- Long lasting
- Molded construction for high ozone resistance and strength
- Resiliency of molded natural rubber for superior cold weather stretch properties

NOTE: Sold by the box of 50 tarp ties. Individual straps are not UPC coded.  
Order quantity of 1 = 50 tarp ties conveniently packed in polybags of 10 each.

**Superior Cold Weather Stretch Properties**

Part Number	Trade Size (Inches)	Length w/Hooks (Inches)
52210C	10"	14"
52215C	15"	19"
52221C	21"	25"
52231C	31"	35"
52241C	41"	45"





# SLINGS & RECOVERY STRAPS





# LIFTING SLINGS

## Polyester Eye to Eye

- Lightweight & economical
- Single-ply & double-ply styles
- WSTDA industry compliant tri-lingual warning tags
- Reinforced loop ends with protective wear sleeve
- Flat eye loops on 1" width
- Tapered eye loops on 2", 3" & 4" widths
- Shrink-wrap package
- Durable service inspection tag helps track usage



All Ankra lifting slings, both eye-to-eye and round sling styles, are built to the Web Sling & Tie Down Association (WSTDA) standards which cover construction, ratings, and markings.

The standard rating for a sling is based on a straight-line pull, or vertical pull, as the WSTDA defines it. This number begins to skew as the rigging style and angle of pull changes. An instruction sheet is included with each sling and the user is responsible for making these calculations.

When the sling is looped through itself to cinch down on the lifted piece, known as a choker-style lift, the lifting capacity is de-rated roughly 20% compared to the vertical rating. This is due to the stress points caused by the sling pinching on itself.

If the lift is being done basket style, utilizing two lifting points, the effective lifting capacity is doubled compared to the vertical rating. Each point can support its original vertical rated capacity.

Per WSTDA requirements, all Ankra lifting slings have these three types of lifts and ratings on their sewn-in tag.

Ankra slings are Lot tested to industry standards when manufactured. We do not provide individual certificates of conformance but, if necessary, can provide a general certificate of conformance which typically covers the customers needs.

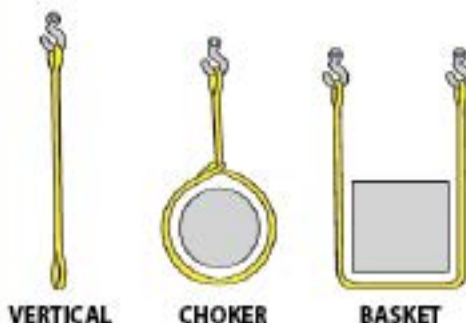

VERTICAL

CHOKER

BASKET

### EE1 Series - Single Ply Slings

#### 1" Width

Vertical WLL - 1,600 lbs (725 kg)

Choker WLL - 1,250 lbs (575 kg)

Basket WLL - 3,200 lbs (1,450 kg)

Part Number	Length (Feet)
20-EE1-9801X3	3'
20-EE1-9801X4	4'
20-EE1-9801X6	6'
20-EE1-9801X10	10'

#### 2" Width

Vertical WLL - 3,100 lbs (1,400 kg)

Choker WLL - 2,450 lbs (1,125 kg)

Basket WLL - 6,200 lbs (2,800 kg)

Part Number	Length (Feet)
20-EE1-9802X3	3'
20-EE1-9802X4	4'
20-EE1-9802X6	6'
20-EE1-9802X10	10'
20-EE1-9802X12	12'
20-EE1-9802X14	14'

### EE2 Series - Double Ply Slings

#### 1" Width

Vertical WLL - 3,100 lbs (1,400 kg)

Choker WLL - 2,450 lbs (1,125 kg)

Basket WLL - 6,200 lbs (2,800 kg)

Part Number	Length (Feet)
20-EE2-9801X4	4'
20-EE2-9801X8	8'

#### 2" Width

Vertical WLL - 6,200 lbs (2,800 kg)

Choker WLL - 4,950 lbs (2,250 kg)

Basket WLL - 12,400 lbs (5,600 kg)

Part Number	Length (Feet)
20-EE2-9802X3	3'
20-EE2-9802X4	4'
20-EE2-9802X6	6'
20-EE2-9802X8	8'
20-EE2-9802X10	10'
20-EE2-9802X12	12'
20-EE2-9802X16	16'
20-EE2-9802X20	20'
20-EE2-9802X30	30'

#### 3" Width

Vertical WLL - 8,800 lbs (3,975 kg)

Choker WLL - 7,000 lbs (3,175 kg)

Basket WLL - 17,600 lbs (7,975 kg)

Part Number	Length (Feet)
20-EE2-9803X10	10'
20-EE2-9803X12	12'
20-EE2-9803X16	16'
20-EE2-9803X20	20'

#### 4" Width

Vertical WLL - 11,000 lbs (4,975 kg)

Choker WLL - 8,800 lbs (3,975 kg)

Basket WLL - 22,000 lbs (9,975 kg)

Part Number	Length (Feet)
20-EE2-9804X6	6'
20-EE2-9804X8	8'
20-EE2-9804X10	10'
20-EE2-9804X12	12'
20-EE2-9804X16	16'
20-EE2-9804X20	20'
20-EE2-9804X30	30'



# LIFTING SLINGS

## Endless Round

- *Lightweight & durable*
- *Low stretch properties for optimum use in low headroom applications*
- *Continuous looped polyester load yarns inside*
- *Abrasion resistant double wall polyester protective cover*
- *Color coded to industry capacity standards*
- *WSTDA industry compliant tri-lingual warning tags*
- *Shrink-wrap package*
- *Design allows sling to be easily rotated to avoid excess stress on a single bearing point*



### 1" Width | Purple

Vertical WLL - 2,600 lbs (1,200 kg)

Choker WLL - 2,100 lbs (1,000 kg)

Basket WLL - 5,200 lbs (2,400 kg)

Part Number	Length (Feet)
20-ENR1X3	3
20-ENR1X4	4
20-ENR1X6	6
20-ENR1X8	8
20-ENR1X12	12



### 2" Width | Green

Vertical WLL - 5,300 lbs (2,400 kg)

Choker WLL - 4,200 lbs (1,900 kg)

Basket WLL - 10,600 lbs (4,800 kg)

Part Number	Length (Feet)
20-ENR2X3	3
20-ENR2X4	4
20-ENR2X8	8
20-ENR2X12	12
20-ENR2X20	20



### 3" Width | Yellow

Vertical WLL - 8,400 lbs (3,800 kg)

Choker WLL - 6,700 lbs (3,000 kg)

Basket WLL - 16,800 lbs (7,600 kg)

Part Number	Length (Feet)
20-ENR3X3	3
20-ENR3X4	4
20-ENR3X8	8
20-ENR3X12	12
20-ENR3X20	20



### 4" Width | Tan

Vertical WLL - 10,600 lbs (4,800 kg)

Choker WLL - 8,500 lbs (3,800 kg)

Basket WLL - 21,200 lbs (9,600 kg)

Part Number	Length (Feet)
20-ENR4X10	10
20-ENR4X16	16



### 5" Width | Red

Vertical WLL - 13,200 lbs (6,000 kg)

Choker WLL - 10,600 lbs (4,800 kg)

Basket WLL - 26,400 lbs (12,000 kg)

Part Number	Length (Feet)
20-ENR5X4	4
20-ENR5X6	6
20-ENR5X12	12
20-ENR5X20	20



### 7" Width | Blue

Vertical WLL - 21,200 lbs (9,600 kg)

Choker WLL - 17,000 lbs (7,600 kg)

Basket WLL - 42,400 lbs (19,200 kg)

Part Number	Length (Feet)
20-ENR7X6	6





# VEHICLE RECOVERY STRAPS

## Cut Case Program

800 Series | Polyester Recovery Straps

15<sup>FT</sup> - 30<sup>FT</sup> Length

2<sup>IN</sup> - 6<sup>IN</sup> Width

- Abrasion resistant
- UV resistant
- Mildew resistant
- Stores easily using sewn in storage band
- Packed in pre-labeled bins for easy merchandising



Part Number	MVW (lbs)	Length (Feet)	Width (Inches)	Case Pack	End Type
800-215H	6,000	15'	2"	5	Safety Hook
800-225H	6,000	25'	2"	5	Safety Hook
800-220	8,000	20'	2"	6	Twisted/Flared Loop
800-230	8,000	30'	2"	6	Twisted/Flared Loop
800-330	12,000	30'	3"	4	Twisted/Flared Loop
800-430	16,000	30'	4"	3	Twisted/Flared Loop
800-630	24,000	30'	6"	2	Twisted/Flared Loop

**MVW**  
(Maximum Vehicle Weight)

The maximum weight of the vehicle being recovered, including cargo load, for which the strap is intended for use.



## Clamshell Options

SL51 | ATV Recovery Rope w/Hooks

13<sup>FT</sup> x 5/8<sup>IN</sup>

3,500 lbs MVW (1,587 kg)

- Durable braided polypropylene rope
- Steel safety hooks



SL31 | Recovery Strap w/Hooks

15<sup>FT</sup> x 2<sup>IN</sup>

5,000 lbs MVW (2,268 kg)

- Polyester webbing
- Steel safety hooks



SL24 | Recovery Strap w/Loops

20<sup>FT</sup> x 2<sup>IN</sup>

9,000 lbs MVW (4,082 kg)

- Polyester webbing
- Twisted sewn loops





# CABLE PULLERS





# CABLE PULLERS

Ankra cable pullers are available in different sizes with pulling capabilities ranging from 2,000 to 8,000 pounds. A variety of pullers are available to make pulls easier and more efficient. In addition to cable pullers, Ankra offers a Gin Wheel and Wire Stretchers for your convenience.



## Standard Grade

- Dual stamped metal ratchet wheels
- High strength, electro-plated steel parts
- Galvanized 3/16" aircraft cable
- Drop forged steel slip hooks w/safety latches



Part Number	Description	Capacity (lbs)	Power Ratio	Take-up (ft/m)
96111	1-Ton Single Line	2,000	1:1	7' (2.2m)
96112	2-Ton Double Line	4,000	2:1	5' (1.5m)
96114	4-Ton Double Line	8,000	2:1	5' (1.5m)



## Professional Grade

Longer handle, larger hooks, thicker frame, and higher take-up than Standard Grade models.

- Dual machined one-piece gears
- High strength, electro-plated steel parts
- Galvanized 3/16" aircraft cable
- Drop forged steel slip hooks w/safety latches



Part Number	Description	Capacity (lbs)	Power Ratio	Take-up (ft/m)
96121	1-Ton Pro Single Line	2,000	1:1	12' (3.6m)
96122	2-Ton Pro Double Line	4,000	2:1	6' (1.8m)

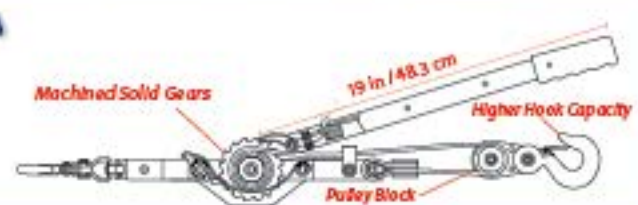

## Specialty Puller

### 96101 | 1-Ton Strap Puller

2,000 lbs Capacity (907 kg) | 12' FT Take-Up (3.6m)

- Dual stamped metal ratchet wheels
- High strength, electro-plated steel parts
- 1" High strength webbing
- 12' Strap & hook assembly included
- Drop forged steel slip hooks w/safety latches on both ends
- Lighter & easier to use than cable

**Great for composite materials & decorative vinyl**

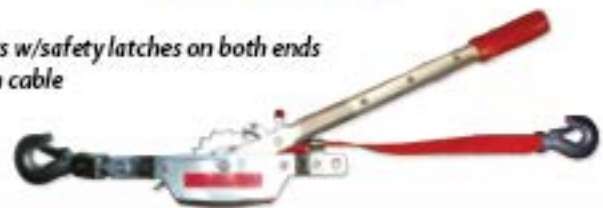

## Accessory Products

### 96148 | Woven Wire Stretcher Quick & Even Stretching

- Makes fence repairs quick and easy
- Ideal for fast tightening
- Pull fence evenly and tightly
- For field and chain link fences
- Dependable design
- Bulk packaging



See previous page for product application

### 96149 | Fencing Wire Stretcher With Control Release Ratchet

- Ideal for fast tightening
- Dependable design
- Makes fence repairs quick and easy
- For high-tensile, smooth and barbed wire
- Hardened guide and clamp grip wire firmly over a large area
- Bulk packaging



### 96146 | Gin Wheel / Rope Pulley 1,250 lbs WLL (567 kg)

- Accepts up to 1" diameter rope
- Heavy duty 12" cast iron sheave
- Forged steel swivel hook w/safety latch
- Blue powder coat finish
- Bulk packaging





# TIE-DOWNS





# INDUSTRIAL / HEAVY DUTY

## Industrial Strap Assembly Components

Tried & tested by professional truck drivers for 50 years, Ancra Industrial Grade ratchet straps are built for the most demanding applications. Quality, care and thought go into every strap ensuring our products perform as intended and outlast the competition.

### 2<sup>IN</sup> STANDARD WIDE HANDLE

- Dichromate finish
- 3.76" Aluminum grip
- 6.25" Handle
- 3,333 lbs WLL / 1,515 kg



### 2<sup>IN</sup> LONG WIDE HANDLE

- Dichromate finish
- 3.76" Aluminum grip
- 8.5" Handle
- 3,666 lbs WLL / 1,662 kg



### 3<sup>IN</sup> LONG WIDE HANDLE

- Dichromate finish
- 4.8" Aluminum grip
- 10.5" Handle
- 7,333 lbs WLL / 3,326 kg



### 4<sup>IN</sup> LONG WIDE HANDLE

- Dichromate finish
- 5.2" Aluminum grip
- 12.5" Handle
- 8,000 lbs WLL / 3,628 kg



### STANDARD HIGH CAPACITY WEBBING



- Latex coated polyester with excellent UV protection and abrasion resistance
- Meets DOT and WSTDA requirements

### X-TREME™ HIGH CAPACITY WEBBING



- Polyester webbing with superior weave pattern and permanent proprietary coating that provides twice the abrasion resistance of standard high capacity webbing and greater resistance to damaging water absorption
- Meets DOT and WSTDA requirements



Flat Hook with Aluminum Edge Guard



Wire Double J-Hook



Twisted Snap Hook



Chain Anchor

## 2<sup>IN</sup> Commercial Grade with Retail Merchandiser

556 Series | Standard Wide Handle Ratchets | 3,333 lbs WLL (1,515 kg)

S-Line branded 

- Standard high capacity webbing
- Shorter fixed end
- Packaged in color coded 9-piece display bins
- Fits nicely on a 14" gondola shelf & can be neatly stacked for end-caps or floor displays

**PERFECT CHOICE FOR CONTRACTOR OR DIY USE**

Part Number	Length (Feet)	Hook Type
556	27'	Flat
556-WHK	27'	Wire Double-J



Flat Hooks 556



Wire Hooks 556-WHK



9 PC Shelf Display Box  
14" x 14" x 10"



## ANATOMY OF A RATCHET STRAP

Our strap assemblies are designed with separate sections. Each section is tagged with the essential assembly information.



### 2" RATCHET STRAPS | 3,333 lbs WLL (1,515 kg)

- S-Line branded 
- Long wide handle
  - Standard high capacity webbing
  - Longer fixed end







Part Number	Length (Feet)	Hook Type
557-15	15'	Flat
557-15WHK	15'	Wire J
<b>557</b>	<b>27'</b>	<b>Flat</b>
<b>557-WHK</b>	<b>27'</b>	<b>Wire J</b>

**TRUCKER'S CHOICE**



### 2" HAY HAULER RATCHET STRAPS | 3,333 lbs WLL (1,515 kg)

- S-Line branded 
- Long wide handle
  - Standard high capacity webbing
  - Color coded for easy identification

Part Number	Length (Feet)	Hook Type	Webbing Color
557-40	40'	Flat	
557-40WHK	40'	Wire J	
557-50	50'	Flat	
557-50WHK	50'	Wire J	
557-60	60'	Flat	
557-60WHK	60'	Wire J	



### HEAVY DUTY RATCHET STRAPS | Standard High Capacity Webbing

Ankra branded 

2" Straps (WLL: 3,333 lbs)			3" Straps (WLL: 5,400 lbs)			4" Straps (WLL: 5,400 lbs)		
Part Number	Length (Feet)	Hook Type	Part Number	Length (Feet)	Hook Type	Part Number	Length (Feet)	Hook Type
45982-10	27'	Flat	48987-20	27'	Flat	49346-10	27'	Flat
45982-19	27'	Twisted Snap	48987-28	27'	Wire J	49346-12	27'	Wire J
45982-15	27'	Chain	48987-24	27'	Chain	49346-14	27'	Chain
45982-42	27'	Wire J	48987-21	30'	Flat	49346-11	30'	Flat
45982-11	30'	Flat	48987-29	30'	Wire J	49346-13	30'	Wire J
45982-43	30'	Wire J	48987-25	30'	Chain	49346-15	30'	Chain
45982-36	30'	Twisted Snap						
45982-34	30'	Chain						

45982-11-30-WK 30' Web Keeper Ratchet

### HEAVY DUTY RATCHET STRAPS | X-TREME™ High Capacity Webbing

Ankra branded 

- Twice the abrasion resistance
- Advanced moisture wicking
- Not recommended for extreme cold climates due to webbing stiffness



2" Straps (WLL: 3,333 lbs)			3" Straps (WLL: 5,400 lbs)			4" Straps (WLL: 5,400 lbs)		
Part Number	Length (Feet)	Hook Type	Part Number	Length (Feet)	Hook Type	Part Number	Length (Feet)	Hook Type
45982-90-27	27'	Flat	48987-90-27	27'	Flat	49346-90-27	27'	Flat
45982-95-27	27'	Wire J	48987-92-27	27'	Chain	49346-93-27	27'	Wire J
45982-90-27-WK	27'	Flat w/ Keeper	48987-90-30	30'	Flat	49346-91-27	27'	Chain
45982-90-30	30'	Flat	48987-92-30	30'	Chain	49346-90-30	30'	Flat
45982-93-30	30'	Chain				49346-93-30	30'	Wire J
45982-95-30	30'	Wire J				49346-91-30	30'	Chain



## COMMERCIAL / MULTI-PURPOSE

Perhaps the highest quality general application tie-downs on the market, our "X" series straps are packed full of features and conveniences and built to endure the rigorous applications of today's professional contractor, light industrial user and avid motorsports enthusiasts. "X" series products are made with heavy duty abrasion resistant polyester webbing and packaged in environmentally conscious and easy to merchandise display boxes that are completely recyclable.

### Packaged Tie-Downs

**XC108-2P | Motorsports | 2 Pack**

8'FT x 1.25" Cam Buckle

WLL: 400 lbs (180 kg)

- Pre-threaded & ready to use
- Soft-tie option built-in
- Full size vinyl coated hooks with keepers
- Sewn loop end to prevent pull through



**XR108-2P | Motorsports | 2 Pack**

8'FT x 1.25" Ratchet

WLL: 700 lbs (318 kg)

- Pre-threaded & ready to use
- Soft-tie option built-in
- Spring loaded webbing storage clamp
- Full size vinyl coated hooks with keepers
- Sewn loop end to prevent pull through



**XR015-1P | General Purpose | 1 Pack**

15'FT x 1" Ratchet

WLL: 500 lbs (227 kg)

- Molded grip ratchet handle
- Full size vinyl coated hooks



**XR015-4P | General Purpose | 4 Pack**

15'FT x 1" Ratchet

WLL: 500 lbs (227 kg)

- Molded grip ratchet handle
- Full size vinyl coated hooks



**XR015-C1P | General Purpose | 1 Pack**

15'FT x 1" Ratchet - Camo

WLL: 500 lbs (227 kg)

- Molded grip ratchet handle
- Full size vinyl coated hooks



**XR115-C2P | General Purpose | 2 Pack**

15'FT x 1.25" Ratchet - Camo

WLL: 700 lbs (318 kg)

- Spring loaded webbing storage clamp
- Full size vinyl coated hooks with keepers
- Extended 19" fixed end to extend ratchet above pick-up rail
- Sewn loop end to prevent pull through



### Commercial Grade Tie-Downs - Bulk

**APS-3 | Heavy Duty | Contractor Grade**

12'FT x 1" Ratchet

WLL: 1,000 lbs (455 kg)

- 3,500 lbs polyester webbing
- Yellow chromate ratchet
- Yellow chromate double J-hooks with floating D-rings on both ends



**APS-15192 | Standard Duty**

16'FT x 1" Ratchet

WLL: 500 lbs (227 kg)

- 2,000 lbs polyester webbing
- Yellow chromate ratchet
- Full size vinyl coated hooks





## Best Selling Multi-Packs



**15FT x 1IN Ratchet**  
**WLL: 500 lbs (227 kg)**  
 • Fully curved vinyl covered S-hooks  
 • Padded grip ratchet handles  
 • Interactive open style package

P/N	Package Style
SL91	4 Pack I-Pack, Orange
95189	Bulk Bin, Orange
SL92	4 Pack I-Pack, Camo
95190	Bulk Bin, Camo



**16FT x 1.25IN Ratchet**  
**WLL: 700 lbs (318 kg)**  
 • Vinyl coated double J-hooks  
 • 1.25" Heavy duty ratchet w/molded grip handle



SL82 | 4 Pack I-Pack, Orange

**6FT x 1IN Cam Buckle**  
**WLL: 300 lbs (135 kg)**  
 • Compact vinyl coated S-hooks



SL27 | 4 Pack Blister, Red

**10FT x 1IN Ratchet**  
**WLL: 300 lbs (135 kg)**  
 • Compact vinyl coated S-hooks



SL16 | 4 Pack Blister, Red

**8FT x 1IN Ratchet - Camo**  
**WLL: 400 lbs (181 kg)**  
 • Padded grip handle  
 • Compact vinyl coated S-hooks



SL66 | 4 Pack Blister, Camo

**16FT x 1.25IN Ratchet**  
**WLL: 700 lbs (318 kg)**  
 • Vinyl coated double J-hooks  
 • 1.25" Heavy duty ratchet  
 • Molded grip handle



SL81 | 2 Pack I-Pack, Orange

## Retractable Ratchets

95370 | 2 Pack  
**6FT x 1IN Ratchet**  
**WLL: 500 lbs (227 kg)**  
 • Push button control



95372 | 2 Pack  
**15FT x 1IN Ratchet**  
**WLL: 500 lbs (227 kg)**  
 • Gear spring design restricts accelerated retraction



## Commercial Grade Tie-Downs - Packaged

10936 Series | Heavy Duty | Contractor Grade  
**WLL: 1,000 lbs (455 kg)**  
**1IN Wide Grip Ratchet**

- 1" Black polyester webbing
- Yellow chromate coated
- Full size vinyl coated hooks
- Bulk packed, rolled, plastic banded & UPC coded
- Packed in shelf merchandiser box
- 15" Fixed end
- 6', 12', 16' and 20' options
- Tri-lingual warning tags



Part Number	Length (Feet)	Hook Type
10936-06	6'	S-hook
10936-12	12'	S-hook
10936-16	16'	S-hook
10936-16J	16'	J-hook
10936-20	20'	S-hook





# CONSUMER MULTI-PURPOSE



**13' x 1" Lashing**  
WLL: 200 lbs (90 kg)

- Great for bundling & roof racks
- Loop style - no hooks

P/N	Package Style
SL48	2 Pack Clam, Black
95180	Bulk Bin, Black



**10' x 1" Ratchet**  
WLL: 300 lbs (135 kg)

- Yellow chromate ratchet
- Full size vinyl coated S-hooks

P/N	Package Style
SL05	1 Pack Clam, Red
95181	Bulk Bin, Red



**13' x 1" Endless Ratchet**  
WLL: 300 lbs (135 kg)

- Great for roof racks
- Forms a loop - no hooks

P/N	Package Style
SL47	1 Pack Clam, Yellow
95182	Bulk Bin, Yellow



**13' x 1" Ratchet**  
WLL: 300 lbs (135 kg)

- Black powder coated ratchet
- Compact vinyl coated S-hooks

P/N	Package Style
SL46	1 Pack Clam, Red



**6' x 1" Cam Buckle**  
WLL: 400 lbs (180 kg)

- Full size vinyl coated S-hooks

P/N	Package Style
SL38	2 Pack Clam, Red
95183	Bulk Bin, Red
95184	Bulk Bin, Camo



**6' x 1" Ratchet**  
WLL: 400 lbs (180 kg)

- ATV/Cycle strap
- Full size vinyl coated S-hooks

P/N	Package Style
SL30	2 Pack Clam, Black
95185	Bulk Bin, Red
95186	Bulk Bin, Camo



**10' x 1" Cam Buckle**  
WLL: 400 lbs (180 kg)

- Full size vinyl coated S-hooks

P/N	Package Style
SL01	1 Pack Clam, Blue
95187	Bulk Bin, Blue



# CONSUMER MULTI-PURPOSE



**15FT x 1IN Ratchet**  
WLL: 500 lbs (225 kg)

- Full size vinyl coated S-hooks
- Padded grip ratchet handles

P/N	Package Style
SL91	4 Pack I-Pack, Orange
95189	Bulk Bin, Orange
SL92	4 Pack I-Pack, Camo
95190	Bulk Bin, Camo



**14FT x 1IN Ratchet**  
WLL: 400 lbs (180 kg)

- Black powder coated ratchet
- Full size vinyl coated S-hooks

P/N	Package Style
SL18	1 Pack Clam, Blue
95188	Bulk Bin, Blue



**15FT x 1IN Ratchet**  
WLL: 600 lbs (272 kg)

- 1" Heavy duty ratchet
- Floating D-rings
- Double J-hooks

P/N	Package Style
95191	Bulk Bin, Blue



**16FT x 1.25IN Ratchet**  
WLL: 700 lbs (318 kg)

- Vinyl coated double J-hooks
- Molded grip handle
- 1.25" Heavy duty ratchet

P/N	Package Style
SL81	2 Pack I-Pack, Orange
SL82	4 Pack I-Pack, Orange



**16FT x 1IN Ratchet**  
WLL: 1,000 lbs (455 kg)

- 1" Heavy duty ratchet
- Floating D-rings
- Double J-hooks

P/N	Package Style
SL100	1 Pack Clam, Black
95192	Bulk Bin, Black



**15FT x 1.5IN Ratchet**  
WLL: 1,666 lbs (756 kg)

- Wide short handle w/aluminum grip
- Double J-hooks
- Heavy duty webbing

P/N	Package Style
SL32	1 Pack Clam, Yellow



**16FT x 1.5IN Ratchet**  
WLL: 1,666 lbs (756 kg)

- Wide short handle w/aluminum grip
- Double J-hooks
- Heavy duty webbing

P/N	Package Style
SL101	1 Pack Clam, Yellow
SL102	2 Pack Clam, Yellow



**16FT x 1.5IN Ratchet**  
WLL: 1,600 lbs (725 kg)

- Wide short handle w/aluminum grip
- Double J-hooks
- Floating D-rings
- Heavy duty webbing

P/N	Package Style
95193	Bulk Bin, Yellow



# VEHICLE TRANSPORT

## Tire Bonnets

- Premium 2" coated webbing for greater abrasion resistance
- Twisted snap hook on fixed end
- Short handle ratchet with built-in snap hook
- Packaged in window box – 1 assembly per box



Tire Bonnets can be special ordered with flat hooks in place of snap hooks. Contact Customer Service for pricing and availability.

Made in USA 

**30TB | Standard Fixed**  
14" - 15" OEM Tires  
No Ratchet  
3,333 lbs WLL (1,515 kg)



**30TB-MS | Standard Fixed**  
14" - 15" OEM Tires  
With Ratchet  
3,333 lbs WLL (1,515 kg)



**30ATB\* | Adjustable**  
13" - 17" OEM Tires  
No Ratchet  
833 lbs WLL (378 kg)



\*30ATB also available in Blue (-BL)

**30ATB-MS-BK\* | Adjustable**  
13" - 17" OEM Tires  
With Ratchet  
833 lbs WLL (378 kg)



\*30ATB-MS also available in Yellow (-YL), Blue (-BL), & Red (-RD)

**30RT-BL\* | Double Adjustable**  
13" - 17" OEM Tires  
10" - 22" OEM Tires  
With Ratchet  
833 lbs WLL (378 kg)



\*30RT also available in Yellow (-YL), Black (-BK), & Red (-RD)

## Basket & Dolly Straps

**45143-20 | Basket Strap**  
1,666 lbs WLL (757 kg)

- For tires 7" w x 20" h
- Weight: 2.25 lbs
- Bulk packaged
- No ratchet



**45143-22**

- For tires 8" w x 24" h
- Weight: 2.5 lbs
- Bulk packaged
- No ratchet

**47934-11 | Wheel Dolly Strap**  
900 lbs WLL (410 kg)

- 2" x 86" With round ring
- For tires 8" w x 22" h
- Weight: 1.0 lbs
- Bulk packaged
- No ratchet



**47935-11 | Wheel Dolly Strap**  
800 lbs WLL (360 kg)

- With S-hooks
- For tires 10" w x 24" h
- Weight: 1.5 lbs
- Bulk packaged
- No ratchet



## Axle Straps

3,333 lbs WLL (1,515 kg)

- 2" Coated webbing for greater abrasion resistance
- Stamped D-rings
- Cordura protective sleeve
- Bulk packaging – individually UPC coded

Made in the USA 



Part Number	Length (Feet)	Color
30A521-BK	21"	Black
30A521-BL	21"	Blue
30A521-RD	21"	Red
30A533-BK	33"	Black
30A533-BL	33"	Blue
30A533-RD	33"	Red



# VEHICLE TRANSPORT

## Vehicle Tie-Downs



- 2" Coated webbing for greater abrasion resistance
- Twisted snap hooks
- Wide handle ratchet
- Packaged in merchandiser box



Part Number	Length (Feet)	Fixed End (Inches)	Working Load Limit (lbs)	Color
500-C6-RD	6'	14"	3,333	Red
500-C8-BK	8'	12"	3,333	Black
500-C8-BL	8'	12"	3,333	Blue
500-C8-RD	8'	12"	3,333	Red
500-C10-BK	10'	12"	3,333	Black

500-C6-RD  
500-C8-RD



500-C8-BK  
500-C10-BK



500-C8-BL



### Heavy Duty Ratchet Strap w/Flat Snap Hooks

- Standard 2" high-capacity polyester webbing
- Short wide handle ratchet
- 6" Fixed end
- No packaging



Part Number	Length (Feet)	Working Load Limit (lbs)
49020-20	6'	1,660
49020-21	8'	1,660
49020-22	12'	1,660

### Series E Transit Strap | RTJ Hooks

Assembled with durable latex treated polyester webbing and short-wide handle ratchet. Fixed end features a heavy duty Series E & A track fitting and the adjustable end features a cluster hook with R, T & J options.



Part Number	Length (Feet)	Working Load Limit (lbs)
49023-20	6'	1,000
49023-21	8'	1,000
49023-22	12'	1,000

### 48487-24 | Auto Hauler Winch Strap 2" x 140" Winch Strap w/Tire Cleats 3,333 lbs WLL (1,515 kg)



The auto tie-down strap goes over the tire and utilizes three cleated rubber pads that mesh with the tread to keep the strap centered and secured.

### Auto Hauler Ratchet Straps

3,333 lbs WLL (1,515 kg)

- Short wide handle
- 2 Rubber tire tread cleats
- 2" High-capacity standard polyester webbing



Part Number	Length (Inches)	End Hook Type	Floating Hook Type
50179-10	102"	Wire Double-J	Wire Double-J
50179-11	102"	Swivel J	Swivel J

### 500-RAS-BK | Tie Back Strap with Integrated Axle Strap

2" x 8' FT  
3,333 lbs WLL (1,515 kg)

- Heavy duty twisted snap hooks
- Stamped D-ring
- Adjustable loop size
- Cordura protective sleeve
- Includes wide handle ratchet with 9" fixed end



Made in the USA 

### 500-TB-BK | Tie Back Strap w/Twisted Snap Hooks

2" x 8' FT  
3,300 lbs WLL (1,497 kg)

- Heavy duty twisted snap hooks
- Stamped D-ring
- Adjustable loop size
- Cordura protective sleeve



### 500-BS | Belly Strap

- 2" x 10' FT
- No hooks
  - Designed to create a loop





# MOTORSPORTS

The leading premium brand in motorcycle tie-downs for over 50 years, Anca Motorsports products stand the test of time. No frills, just high quality with high performing webbing.

## 40888 Originals & 49380 Integras Series | 2 Packs

1" Cam Buckle w/S-Hooks

400 lbs WLL (180 kg)

- 4,500 lbs tensile strength nylon webbing
- 1,800 lbs rated heavy duty cam buckle with pressure plate
- 2 Vinyl coated S-hooks per strap, rated at 1,200 lbs each

Part Number	Length (Inches)	Style	Soft Hook	Color
40888-10	66"	Originals	No	Red
40888-26	66"	Originals	No	Black
40888-28	66"	Originals	No	Green
40888-34	66"	Originals	No	Blue
49380-10	69"	Integras	Yes	Red
49380-11	69"	Integras	Yes	Black
49380-12	69"	Integras	Yes	Blue



## 49970-102 | Integra Big Bike Gradual Release Ratchet\* | 2 Pack

66" x 1.5" Ratchet w/S-Hooks & Integrated Soft Hook

800 lbs WLL (363 kg)

- Patented gradual release ratchet
- Wide easy grip ratchet handle
- Durable 1.5" high-test webbing
- Full size vinyl coated S-hooks
- Positive locking latch



\*Gradual release ratchet allows the tension to be let out slowly, instead of unloading rapidly



## 47439 Series | Rat Pak™ | 2 Pack

66" x 1" Ratchet w/S-Hooks

400 lbs WLL (180 kg)

- 4,500 lbs tensile strength high-test webbing
- 4,400 lbs rated ratchet
- 2 Vinyl coated S-hooks per strap, rated at 1,200 lbs each



Part Number	Color
47439-10	Red
47439-11	Black



## 49498 Series | Integra Rat Pak™ | 2 Pack

69" x 1" Ratchet w/S-Hooks & Integrated Soft Hook

400 lbs WLL (180 kg)

- 4,500 lbs tensile strength high-test webbing
- 4,400 lbs rated ratchet
- 2 Vinyl coated S-hooks per strap, rated at 1,200 lbs each



Part Number	Color
49498-10	Red
49498-11	Black
49498-12	Blue



## 40890-10 | Bolt On Fitting Kit

1,000 lbs WLL (455 kg)

- Can be installed in pick-up truck, trailer or van
- Anchor plate machined from aluminum extrusion
- Backing plate adds support to truck & van beds & walls
- Aircraft quality single stud fitting with ring



## 47295-10 | Anca Lites | 2 Pack

66" x 1" Cam Buckle w/S-Hooks

330 lbs WLL (150 kg)

- 3,800 lbs tensile strength high-test webbing
- 1,500 lbs rated cam buckle
- 2 S-hooks per strap, rated at 1,200 lbs each
- 1 Vinyl coated S-hook, 1 plated S-hook



## 45214 Series | Soft Hook Extensions | 2 Pack

400 lbs WLL (180 kg)

- Protect paint & chrome attachment surfaces
- Eliminates metal-to-metal contact
- 3,800 lbs tensile strength high-test webbing



Part Number	Length (Inches)	Color
45214-14	12"	Black
45214-10	18"	Black





# TRANSPORT CHAIN & CHAIN BINDERS

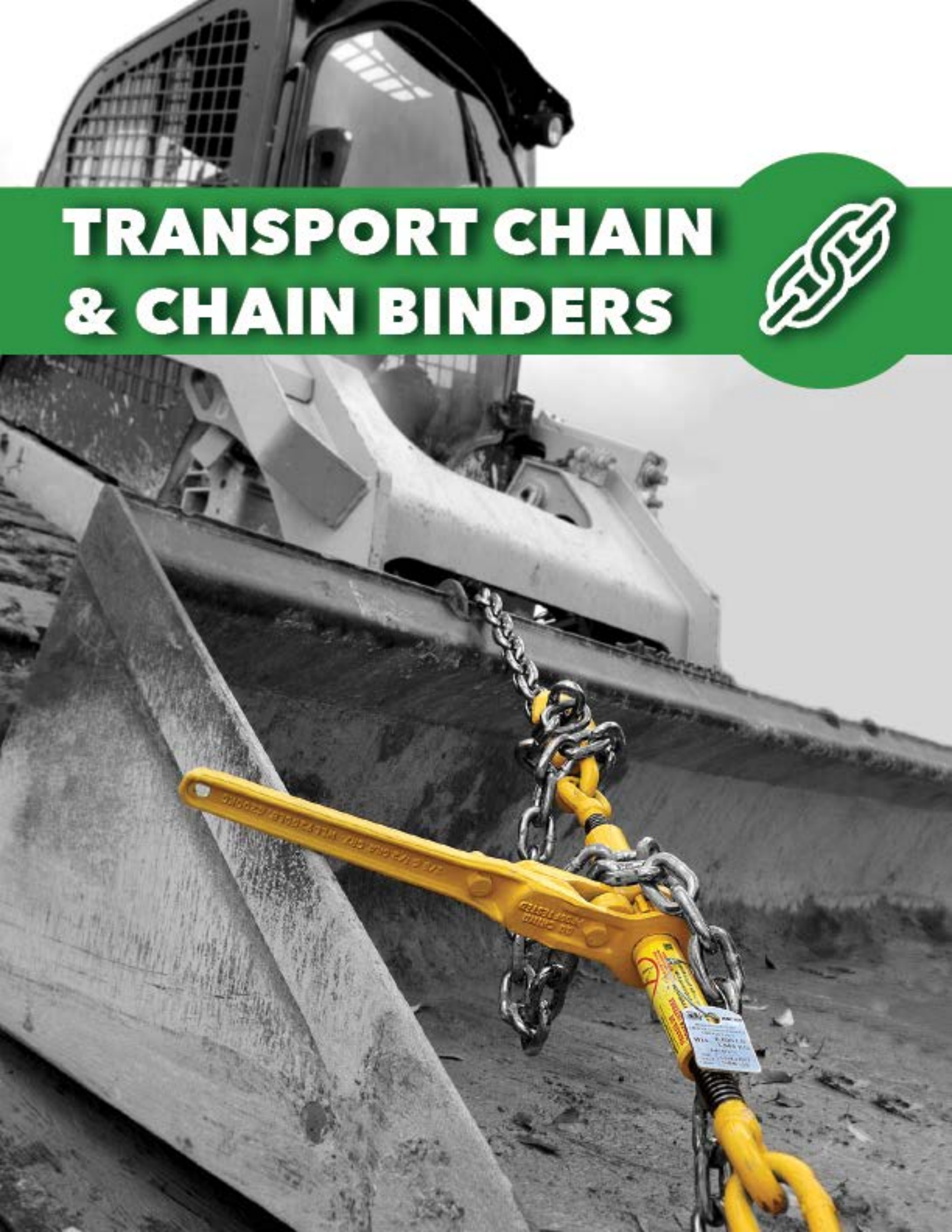



# TRANSPORT CHAIN

## Transport Chain Assemblies

### Grade 70 | Chain Assemblies

- High strength carbon alloy steel
- Zinc plated gold chromate for corrosion resistance
- Clevis hooks made of heat treated alloy steel
- Designed for over-the-road transportation
- Packed in polybag with upc and warning label, 10 per drum

Color Coded Barrels for Easier Identification



Also available in single piece stackable and reusable plastic storage tub. (SP)



**5/16" Chain**  
4,700 lbs WLL (2,131 kg)

Part Number	Length (Feet)	Package Type
45881-10-16	16'	drum/bag
45881-10-16-SP	16'	plastic tub
45881-10-20	20'	drum/bag
45881-10-20-SP	20'	plastic tub
45881-10-25	25'	drum/bag
45881-10-25-SP	25'	plastic tub

**3/8" Chain**  
6,600 lbs WLL (2,990 kg)

Part Number	Length (Feet)	Package Type
45881-11-16	16'	drum/bag
45881-11-16-SP	16'	plastic tub
45881-11-20	20'	drum/bag
45881-11-20-SP	20'	plastic tub
45881-11-25	25'	drum/bag
45881-11-25-SP	25'	plastic tub

**1/2" Chain**  
11,300 lbs WLL (5,126 kg)

Part Number	Length (Feet)	Package Type
45881-13-20	20'	drum/bag
45881-13-25	25'	drum/bag

### Grade 70 | XHD Chain Assembly 3/8" Chain w/G80 Hooks 6,600 lbs WLL (2,990 kg)

- High strength carbon alloy steel
- Zinc plated gold chromate for corrosion resistance
- Grade 80 clevis hooks made of heat treated alloy steel
- Designed for over-the-road transportation
- Stamped aluminum Working Load Limit tag
- Individually UPC coded, packed in heavy duty cardboard box

Part Number	Length (Feet)	Package Type
50364-38-10	10'	box
50364-38-20	20'	box



19% more material in the neck for added strength

### 50529-11-10-BX | Grade 100 Chain Assembly 3/8" x 10" FT 8,800 lbs WLL (4,000 kg)

- Heat treated high carbon alloy steel
- Rugged black lacquer finish
- Blue powder coated clevis grab hooks
- Stamped aluminum Working Load Limit tag
- Individually UPC coded, packed in heavy duty cardboard box



### Grade 80 J-Hook Chain Assemblies 3/8" Chain 7,100 lbs WLL (3,221 kg)

- Great for securing large equipment
- Heat treated high carbon alloy steel
- Rugged black lacquer finish
- Yellow powder coated J-hooks
- Stamped aluminum Working Load Limit tag
- UPC coded, packed in heavy duty cardboard boxes in quantity listed

**Attaches quickly to built-in Anchor Point**

Part Number	Length (Feet)	Chain End Hardware	Chain Grade	Package Qty
50378-10-10	10'	15" J-Hook G80 Clevis	G80	1
50378-11-05-2	5'	15" J-Hook	G80	2
50739-10-05-2	5'	8" J-Hook	G80	2



50378-10-10



50378-11-05-2



50739-10-05-2

### Grade 43 | Chain Assemblies 3/8" Chain 5,400 lbs WLL (2,449 kg)

- High strength carbon steel
- Great for general tie-down use & logging
- Packed in polybag with upc and warning label, 10 per drum



Part Number	Length (Feet)	Package Type
49958-38-20	20'	drum/bag
49958-38-20-SP	20'	plastic tub

Manufactured to NACM Standards. Chain Links marked every 6 inches. NOTE: Not for overhead lifting.



# TRANSPORT CHAIN & CHAIN HARDWARE

## Grade 70 Bulk Chain (No Hooks)

**45880-12**  
1/4" x 400<sup>FT</sup>  
3,150 lbs WLL (1,430 kg)



**45880-10**  
5/16" x 400<sup>FT</sup>  
4,700 lbs WLL (2,131 kg)



**45880-11**  
3/8" x 200<sup>FT</sup>  
6,600 lbs WLL (2,990 kg)



**45880-13**  
1/2" x 100<sup>FT</sup>  
11,300 lbs WLL (5,126 kg)



Manufactured to NACM Standards. Chain Links marked every 6 inches. NOTE: Not for overhead lifting.

## Hooks

### Clevis Hooks | Grade 70

- Forged & heat treated
- Individually polybagged w/UPC
- Retail pack quantity 1

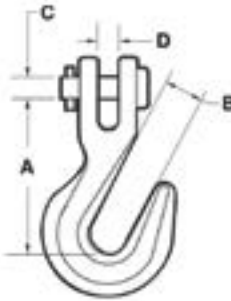

Part Number	Size (Inches)	Working Load Limit (lbs)	Working Load Limit (kg)
45946-12	1/4"	3,150	1,430
45946-10	5/16"	4,700	2,131
45946-11	3/8"	6,600	2,990
45946-13	1/2"	11,300	5,126

Dimensions	A	B	C	D
45946-12	2.00	.40	.31	.36
45946-10	2.30	.43	.38	.38
45946-11	2.70	.50	.48	.44
45946-13	3.20	.66	.63	.75

### Slip Hooks | Grade 70

- Forged steel with zinc plated gold chromate
- Individually polybagged w/UPC
- Retail pack quantity 1

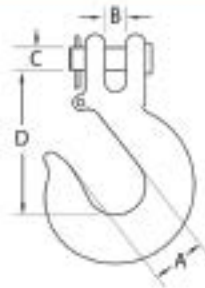

Part Number	Size (Inches)	Working Load Limit (lbs)	Working Load Limit (kg)
50019-10	1/4"	3,150	1,430
50019-11	5/16"	4,700	2,131
50019-12	3/8"	6,600	2,990
50019-13	1/2"	11,300	5,126

Dimensions	A	B	C	D
50019-10	.94	.44	.38	2.44
50019-11	1.06	.41	.44	2.72
50019-12	1.31	.59	.47	3.25
50019-13	1.75	.75	.63	4.00

### Slip Hooks with Safety Latch | Grade 70

- Forged steel with zinc plated gold chromate
- Individually polybagged w/UPC
- Retail pack quantity 1

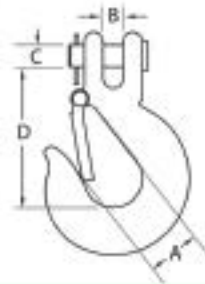

Part Number	Size (Inches)	Working Load Limit (lbs)	Working Load Limit (kg)
50019-20	1/4"	3,150	1,430
50019-21	5/16"	4,700	2,131
50019-22	3/8"	6,600	2,990
50019-23	1/2"	11,300	5,126

Dimensions	A	B	C	D
50019-20	.94	.44	.38	2.44
50019-21	1.06	.41	.44	2.72
50019-22	1.31	.59	.47	3.25
50019-23	1.75	.75	.63	4.00

## Clevis Pin Replacements

High strength steel replacement clevis pins are designed to meet the strength requirements of Grade 70 hooks & their heads are marked G7 or 70.

**50412-100** Packaged Kit includes one zinc plated clevis pin & cotter pin for 5/16 Grade 70 chain hook. Weight: .17 lbs / .07 kg

**50412-102** Packaged Kit includes one zinc plated clevis pin & cotter pin for 3/8 Grade 70 chain hook. Weight: .22 lbs / .09 kg

**50412-103** Packaged Kit includes one zinc plated clevis pin & cotter pin for 1/2 Grade 70 chain hook. Weight: .23 lbs / .10 kg

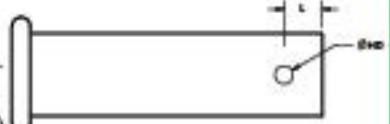



# CHAIN BINDERS

All traditional chain load binders are constructed of drop forged steel for strength and durability and are designed for use with Grade 70 transport chain. They are available in traditional Lever, Recoilless and Ratcheting models, and are finished in an E-coat paint. They meet or exceed WSTDA T-6 standards.

## Standard Ratchet | Built-in Thread Safety Stops

- 1 Piece handle
- Pinned barrel
- Retail pack 1
- Bulk packaged with UPC

Part Number	Size (Inches)	Working Load Limit (lbs)
45943-22	1/4" - 5/16"	2,600
45943-20	5/16" - 3/8"	5,400
45943-20HD	5/16" - 3/8"	6,600
45943-21	3/8" - 1/2"	9,200
45943-23	1/2" - 5/8"	13,000



**Super Smooth Ratcheting Action**

## XHD™ Ratchet | Built-in Thread Safety Stops

- High visibility yellow E-coat
- Drop forged steel
- 2 Piece handle
- Welded barrel
- Retail pack 1
- Bulk packaged with UPC

Part Number	Size (Inches)	Working Load Limit (lbs)
50360-20	5/16" - 3/8"	6,600
50360-21	3/8" - 1/2"	9,200



**Superior Durability**

## 50117-10 | Lever Binder Lock

Lock your chain & lever in place after tightening with our Lever Binder Lock.



## Mini Chain Tightener

- Retail pack 1
- Bulk packaged with UPC

Part Number	Finish	Working Load Limit (lbs)
50025-10	E-Coat	375



## Standard Lever | Drop Forged Steel Construction

- Retail pack 1
- Bulk packaged with UPC

Part Number	Size (Inches)	Working Load Limit (lbs)
45943-12	1/4" - 5/16"	2,600
45943-10	5/16" - 3/8"	5,400
45943-10HD	5/16" - 3/8"	6,600
45943-14*	5/16" - 3/8"	5,400
45943-11	3/8" - 1/2"	9,200
45943-13	1/2" - 5/8"	13,000

\* Recoilless Lever Chain Binder



## EZ Binders™

### Use with 5/16" - 3/8" Chain

- Up to 90% faster than an equivalent ratchet binder
- Quick acting ratchet design is easy to tension and release
- Extra long handle with contour grip
- Heavy gauge steel construction
- Corrosion resistant electro zinc plating
- Free wheel function for quick take up
- Swiveling grab hooks for ease of use
- 12" Take up

Part Number	Description	Working Load Limit (lbs)
50140-10	EZ Binder <sup>1000</sup>	5,400
50140-11	EZ Binder <sup>6000</sup>	6,600



Scan this QR Code to see a video on how easy it is to use.

**Works like a Ratchet Strap!**

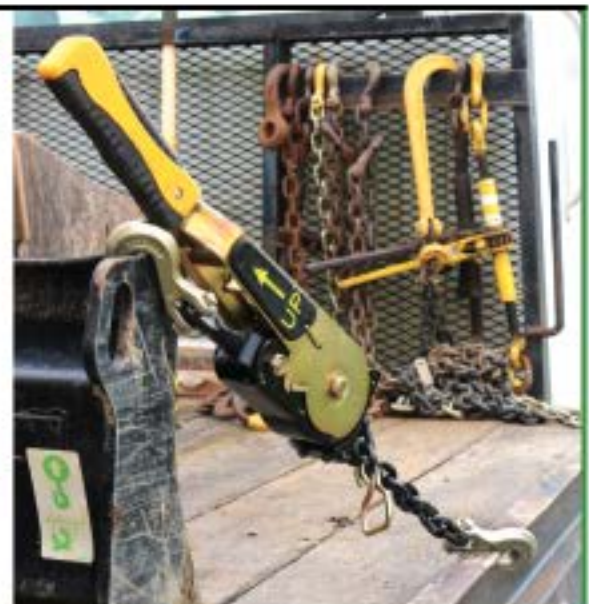



# HEAVY DUTY





# FLAT BED SOLUTIONS

## Corner Protectors

### X-TREME Guard® | 12" - 48" Plastic

- Constructed of high density polyethylene for strength and durability
- Spreads the strap tension over the length of the guard
- More durable than wood and greater memory than aluminum
- Weather and UV resistant, good to -30°F
- Sold in bundles of 10 - each piece UPC labeled

Part Number	Trade Size (Inches)
50089-12	12"
50089-24	24"
50089-39	39"
50089-48	48"

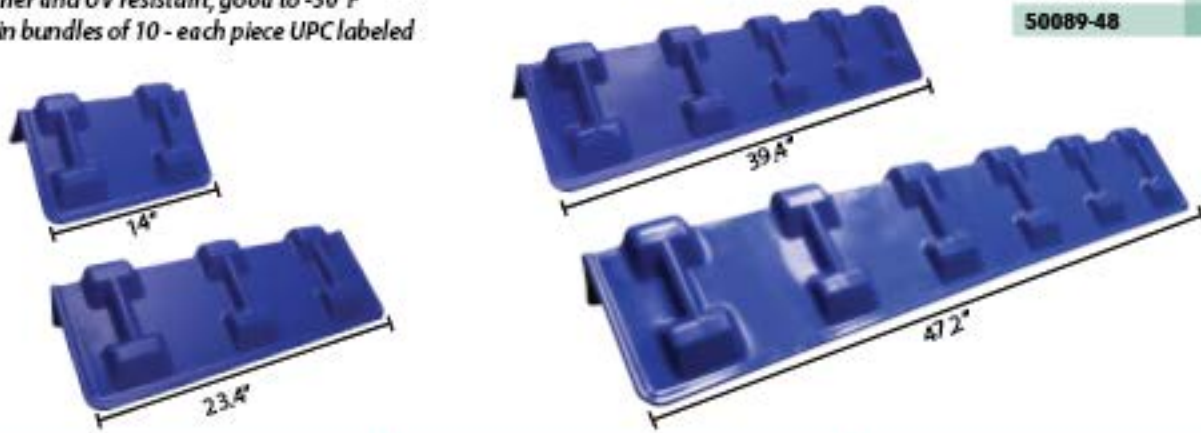

### 42098-12 | Rubber Sleeve

- Extends 5" to protect the load
- For webbing up to 4" wide



### 49377-11 | 4" Rubber Coated Steel

- For use with chain
- Extends 4" to protect load



### 50451-21 | Corner Protector Placement Tool

- Lightweight, telescoping tool extends 4' to 8'
- Powder-coated steel handle
- Designed specifically to work with Ancra Extreme Guard corner protectors
- Works well with most other Ancra corner protectors



### 49584-10 | 12" HD Plastic

- Extends approx. 3" to protect the load
- Takes up to 4" webbing
- Weather resistant, good to -20°F



### 43986-10 | 4" HD Plastic

- Takes up to 4" webbing
- High density polymer
- Bulk packaged with UPC



### 41516-11 | 4" Aluminum

- For 2" webbing



### 49377-10 | 4" Zinc Plated Steel

- For use with chain
- Extends 4" to protect load



### 49577-10 | 4" Chain Plate

- Steel (Galvanized)
- For use with chain
- 4" wide and extends 3" on top and 3.5" on bottom to protect the load



### 49756-10 | 4" Steel

- For use with chain
- Up to 4" winch straps and extends 3-5/8" to protect the load



### 49913-10 | Tarp Protector

- Yellow plastic





# FLAT BED SOLUTIONS

## Winch Straps

### Webbing Types

#### Standard High Capacity Webbing (SHC)



- Latex coated polyester with excellent UV protection and abrasion resistance

#### X-TREME™ High Capacity Webbing



- Polyester webbing with superior weave pattern and permanent proprietary coating that provides twice the abrasion resistance of standard high capacity webbing and greater resistance to damaging water absorption

### End Hardware



Chain End



Delta Ring



Flat Hook



Grab Hook



Sewn Loop



Wire Hook

### 2" STRAPS - SHC

3,333 lbs WLL (1,515 kg)

- Bulk packaged
- Retail pack quantity 1
- Tri-lingual warning tags



Part Number	Length (Feet)	Hook Type
41689-10-27	27'	Flat
41689-11-27	27'	Delta Ring
41689-13-27	27'	Wire Hook
41689-10-30	30'	Flat
41689-11-30	30'	Delta Ring
41689-13-30	30'	Wire Hook

### 3" STRAPS - SHC

5,400 lbs WLL (2,450 kg)

- Bulk packaged
- Retail pack quantity 1
- Tri-lingual warning tags



Part Number	Length (Feet)	Hook Type
41660-10-27	27'	Flat
41660-10-30	30'	Flat
41660-18-30	30'	Wire Hook

### 4" STRAPS - SHC

5,400 lbs WLL (2,450 kg)

- Bulk packaged
- Retail pack quantity 1
- Tri-lingual warning tags



#### 4" FLAT HOOK

Part Number	Length (Feet)	Hook Type	Webbing Type
43795-10-27	27'	Flat	SHC
43795-10-30	30'	Flat	SHC
43795-10-35	35'	Flat	SHC
43795-10-40	40'	Flat	SHC
43795-10-50	50'	Flat	SHC
43795-10-60	60'	Flat	SHC

#### 4" GRAB HOOK

Part Number	Length (Feet)	Hook Type	Webbing Type
43795-14-27	27'	Grab Hook	SHC
43795-14-30	30'	Grab Hook	SHC

#### 4" SEWN LOOP

Part Number	Length (Feet)	Hook Type	Webbing Type
43795-13-30	30'	Sewn Loop	SHC
43795-13-45	45'	Sewn Loop	SHC
43795-13-65	65'	Sewn Loop	SHC
43795-13-75	75'	Sewn Loop	SHC

#### 4" DELTA RING

Part Number	Length (Feet)	Hook Type	Webbing Type
43795-11-27	27'	Delta Ring	SHC
43795-11-30	30'	Delta Ring	SHC
43795-11-35	35'	Delta Ring	SHC
43795-11-40	40'	Delta Ring	SHC
43795-11-50	50'	Delta Ring	SHC

#### 4" CHAIN ANCHOR

Part Number	Length (Feet)	Hook Type	Webbing Type
43795-15-27	27'	Chain Anchor	SHC
43795-15-30	30'	Chain Anchor	SHC
43795-15-40	40'	Chain Anchor	SHC

#### 4" SPECIALTY

Part Number	Length (Feet)	Hook Type	Webbing Type
43795-19-30	30'	None	SHC
43795-40-30	30'	Flat	SHC - Blue
43795-60-30	30'	Flat	SHC - Red
214-30KP	30'	Flat w/ Keeper	SHC



# FLAT BED SOLUTIONS

## X-Treme™ Winch Straps

- Bulk packaged
- Retail pack quantity 1
- Tri-lingual warning tags



Chain End



Delta Ring



Flat Hook



Grab Hook



Sewn Loop



Wire Hook

### 2" Straps - X-Treme

Part Number	Length (Feet)	Width (Inches)	Working Load Limit (lbs)	Hook Type
41659-90-27	27'	2"	3,333	Flat
41659-90-30	30'	2"	3,333	Flat
41659-92-30	30'	2"	3,333	Wire Hook
41659-93-30	30'	2"	3,333	Chain Anchor
41659-94-30	30'	2"	3,333	None

### 4" Straps - X-Treme

Part Number	Length (Feet)	Width (Inches)	Working Load Limit (lbs)	Hook Type
43795-90-27	27'	4"	5,400	Flat
43795-91-27	27'	4"	5,400	Delta Ring
43795-90-30	30'	4"	5,400	Flat
43795-91-30	30'	4"	5,400	Delta Ring
43795-92-30	30'	4"	5,400	Sewn Loop
43795-93-30	30'	4"	5,400	Sewn Loop
43795-95-30	30'	4"	5,400	Chain Anchor
43795-90-40	40'	4"	5,400	Flat
43795-91-40	40'	4"	5,400	Delta Ring



## 4" x 5' Roll-on / Roll-off Container Straps

5,400 lbs WLL (2,450 kg)

Part Number	End Type	Webbing Type
49526-10	N/A	SHC
49526-11	Loop	SHC
49526-90	N/A	X-Treme
49526-91	Loop	X-Treme



## Winch Strap Accessories

### 50092-10 | EZ Winder

- Quickly and easily winds straps onto winches for storage when not in use
- Carded package of 1
- Tri-lingual warning tags



### 45801-10 | WebWinder

- Quickly and easily wind 2", 3" & 4" straps for compact storage
- All steel construction
- Clamps to vehicle rails



### 50391-10 | Deluxe Web Winder

- Quickly and easily wind 2", 3" & 4" straps for compact storage
- Premium zinc-plated steel construction
- Clips into stake pockets or onto side rails



### 50409-10-1PK | TOSS 'N TIE™ Tie-Down Placement Tool

EASY TO USE

- 1) Unroll cord & attach to a cargo strap or cargo chain
- 2) Toss the TOSS 'N TIE ball up & over load
- 3) Go to other side, grab cord & pull your tie-down into place



### 50433-10 | Winch Strap Storage Band

- Keeps stored straps from unrolling
- 1" By 7" long
- Made of natural rubber
- Pack of 5



### 40985-05-12 - 12" 40985-05-RL - 100 yd roll Web Protector

- Cordura nylon sleeve
- For 2" webbing





## ANATOMY OF A WINCH STRAP

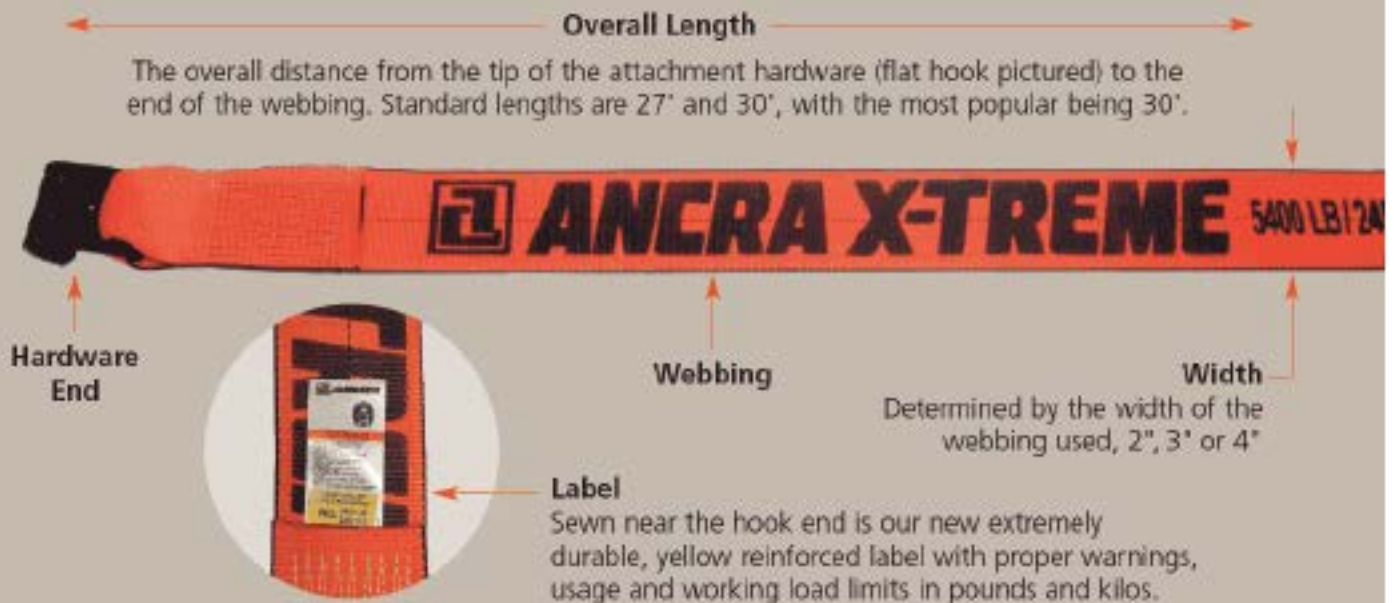

## THE IMPORTANCE OF SECURING CARGO



### ROAD DEBRIS

#### ACCIDENT FATALITIES & INJURIES

From 2011 - 2014 there were more than 200,000 police-reported crashes that listed Road Debris as a factor. This resulted in approximately 39,000 involved injuries and 500 deaths.

20 lbs + 55 mph = 1,000 lbs

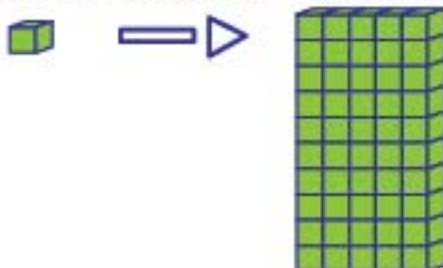

### UNSECURED LOAD

#### STATE FINES & PENALTIES

All 50 U.S. States, plus the District of Columbia, have fines ranging from \$10-\$5,000 for loads that are not properly secure. At least 16 states also add possible imprisonment.



### FORCE OF IMPACT

#### STATIONARY VS MOVING

A 20-pound object traveling at 55 mph hits with the force of 1,000 pounds at the time of impact.

Information from the AAA Foundation.



# FLAT BED SOLUTIONS

## Winches

Ankra winches comply with DOT, WSTDA-T3 and Canadian Standard 905 regulations. Available in different base configurations to suit a variety of needs and load requirements.

All winches shown are right hand models. Left hand models may be available on special orders.

- Powder coating withstands 250 hours of standard salt spray testing to ensure years of service
- Stamped working load limit and Ankra name certify quality
- High-strength alloy pawl pins
- Seamless solid steel mandrel
- Smooth ground web slots prevent web wear

Low Profile - for clearance issues

Standard - Holds 30' of webbing

Storable - Holds up to 40' of webbing

Portable - Repositionable on track or with bolts

7MM - Heat treated 7MM frame reduces average weight per winch by 2 lbs improving fuel economy & payload capacity

Part Number	Winch Type	Surface Treatment	Working Load Limit (lbs)	Attachment	Mount Placement
43488-20	Web/Cable	Black Lacquer	5,500	Weld-On	Side Frame
43563-10	Standard	Black Lacquer	5,500	Weld-On	Bottom
43564-127	Portable	Black Powder Coat	5,500	Bolt-On	Side Frame
43564-147	Portable	Black Powder Coat	5,500	Bolt-On	Side Frame
43564-167	Portable	Black Powder Coat	5,500	Bolt-On	Side Frame
43565-14	Storable	Black Powder Coat	6,000	Slider	C-Track
43565-127	Storable	Black Powder Coat	6,000	Slider	C-Track
43565-127-XZ	Storable	X-treme Zinc	6,000	Slider	C-Track
43565-137	Standard	Black Powder Coat	6,000	Slider	C-Track
43565-157	Standard	Black Powder Coat	6,000	Slider	C-Track
43565-157-XZ	Standard	X-treme Zinc	6,000	Slider	C-Track
43573-10	Storable	Black Lacquer	5,500	Weld-On	Bottom
43579-20	Low Profile	Black Lacquer	5,500	Weld-On	Side Frame
48101-103	Low Profile	Black E-Coat	6,000	Weld-On	Side Frame
48101-143	Standard	Black E-Coat	6,000	Weld-On	Bottom
49207-127	Storable	Black Powder Coat	5,500	Slider	Double L-Track
49207-127-XZ	Storable	X-treme Zinc	5,500	Slider	Double L-Track
49207-137	Standard	Black Powder Coat	5,500	Slider	Double L-Track
49207-137-XZ	Standard	X-treme Zinc	5,500	Slider	Double L-Track
49207-187	Low Profile	Black Powder Coat	5,500	Slider	Double L-Track
49207-187-XZ	Low Profile	X-treme Zinc	5,500	Slider	Double L-Track
49207-273	Standard	Black Powder Coat	5,500	Slider	Double L-Track
49207-273-XZ	Standard	X-treme Zinc	5,500	Slider	Double L-Track
49207-283-XZ	Low Profile	X-treme Zinc	5,500	Slider	Double L-Track
49706-10	Standard	Black Powder Coat	5,500	Slider	Wilson Track

### Cable



43488-20  
• Low Profile  
• Side Mount

### DID YOU KNOW?

**3-Bar:** Designed for easy strap insertion during snow & ice conditions. Prevents mandrel from freezing up.  
**Double Cap:** Incremental adjustment from both sides of the winch allows for clearance applications.  
**Sliders:** Allow for easy positioning on the truck, and lock into place when tension is applied to the strap.

### Weld-On



43563-10  
• Standard  
• Bottom Mount



48101-143  
• 3-Bar Standard  
• Bottom Mount



43573-10  
• Storable  
• Bottom Mount



48101-103  
• 3-Bar Low Profile  
• Side Mount  
• Extended Pawl



43579-20  
• Low Profile  
• Side Mount

### Portable / Bolt-On



43564-147  
• Standard



43564-127  
• Storable



43564-167  
• Low Profile

**CAUTION: 7MM Winches should not be welded due to welding affect on the strength provided by the heat treating process.**

**Avoid welding zinc treated parts due to toxic fumes.**



# FLAT BED SOLUTIONS

## C-Track Sliders



7MM  
43565-157  
• Standard



7MM  
43565-127  
• Storable



43565-14  
• Storable  
• Side Washers



7MM  
43565-137  
• Standard  
• Double Cap



7MM  
XZ  
43565-157-XZ  
• Standard



7MM  
XZ  
43565-127-XZ  
• Storable

## L-Track Sliders



7MM  
49207-137  
• Standard  
• Extended Pawl



49207-273  
• 3-Bar Standard



7MM  
49207-187  
• Low Profile



7MM  
49207-127  
• Storable



7MM  
XZ  
49207-187-XZ  
• Low Profile



7MM  
XZ  
49207-127-XZ  
• Storable



7MM  
XZ  
49207-137-XZ  
• Standard



7MM  
XZ  
49207-273-XZ  
• 3-Bar Standard



7MM  
XZ  
49207-283-XZ  
• 3-Bar Low Profile

## Wilson Track Sliders



49706-10  
• Standard

# X-TREME ZINC™

- X-Treme Zinc Coated
- Better Corrosion Protection
- Longer Lasting

Black powder coat is the standard finish for most winches.

Smooth ground web slots prevent web wear.

Seamless solid steel mandrel.



Powder coating withstands 250 hours of standard salt spray testing to ensure years of service.

Stamped working load limit & Ancra name certify quality.

High-strength alloy pawl pins.



# FLAT BED SOLUTIONS

## Ratcheting Winches

Faster and more convenient than traditional winches. Reduces the tensioning time by 33%. Also, reduces risk of winch bar rollover. Once the winch bar tip is inserted into the winch cap, the winch can be fully tensioned without the need to repetitively remove and reposition the winch bar.

Part Number	Winch Type	Surface Treatment	Working Load Limit (lbs)	Attachment	Mount Placement
43563-10-RW	Standard	Black Lacquer	5,500	Weld-On	Bottom
43565-127-RW	Storable	Powder Coat	6,000	Slider	C-Track
43565-157-RW	Storable	Black Lacquer	6,000	Slider	C-Track
49207-137-RW	Portable	Powder Coat	5,500	Slider	L-Track
49207-187-RW	Low Profile	Powder Coat	5,500	Slider	L-Track



Watch this Video to Learn More!



## Specialty Winches

- 49716-10 | Porta Winch - Outward Offset
  - 49716-11 | Porta Winch - Inward Offset
  - 49716-10-RW | Ratcheting Porta Winch - Outward Offset
- 5,500 lbs WLL (2,500 kg)

- Installs easily without tools
- Fasten straps securely and legally
- Inserts into standard trailer stake pockets



**Inward Offset allows for track mounted tarp clearance**



**FOR STAKE POCKET APPLICATIONS**

- 49717-10 | Porta Anchor - Outward Offset
- 5,500 lbs WLL (2,500 kg)
- Installs easily without tools
  - Fasten straps securely and legally
  - Inserts into standard trailer stake pockets



- 47640-31 | Lashing Winch
- 3,300 lbs WLL (1,515 kg)
- Double hex drive & 3 mounting holes
  - Bolt on/Weld on
  - Side frame
  - Black lacquer



**Perfect for Ladder Racks & Construction Vehicles**

- 49723-10 | SilverCap OverDrive®
- 5,500 lbs WLL (2,500 kg)
- Converts standard winches to ratcheting winches
  - Works with weld-on, sliding, or portable mount winches
  - Reduces time needed to load & unload cargo
  - Lowers stress & fatigue on operators

**TURN STANDARD WINCHES INTO RATCHETING WINCHES QUICK & EASILY**



## Winch Track

C-Track



L-Track



Part Number	Length	Material Type	Attachment Method	Track Type
42357-11	6'	Steel	Weld-On	C-Track
42357-12	12'	Steel	Weld-On	C-Track
42357-21	6'	Aluminum	Bolt-On	C-Track
49242-10-120	10'	Aluminum	Bolt-On	Double L-Track



# FLAT BED SOLUTIONS

## Winch Bars

All winch bars are made from heat treated steel for extra strength and designed for use with standard winch caps. Each bar has a knurled handle in two sections for improved grip and a flanged mushroom tip end to keep the bar from slipping within the winch cap.

### 42313-10 | 34" Standard Black

- Black powder coat finish



### 42313-12 | 34" Combination Box End

- Painted silver & yellow finish
- Chain binder release end



### 42313-17 | 34" Standard Chrome

- Chrome finish



### 42313-19 | 34" Combination Chrome

- Chrome finish
- Open ended



*Goose Neck design reduces the number of times the operator needs to remove & replace the bar to tighten the strap. Also allows operator to keep the bar in a safer more ergonomic position to prevent back injuries & injuries caused by bar slippage from winch cap.*

### 50015-10 | 34" ERGO 360° Standard



### 50015-20 | 34" ERGO 360° Combination

- Open ended



### 50015-21 | 34" ERGO 360° Combination Box End

- Chain binder release end



## Accessories

### 49344-12 | Coil Rack

- Heavy duty
- 14" Steel sheet per ASTM A36
- Black lacquer finish



### 49345-10 | Floor Chain Tie-Down

- Weld-on
- 3/8" G70 transport chain
- Black E-coat
- 6,000 lbs WLL

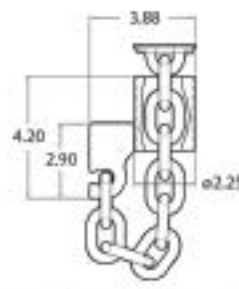

### 49583-10 | Floor Chain Tie-Down

- Bolt-on
- 3/8" G70 transport chain
- Zinc plated
- 6,000 lbs WLL

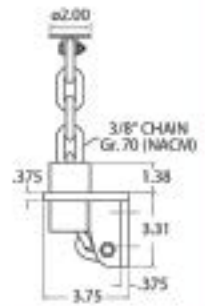

### 50105-11 | Poly Deckboard

- 48" x 48" x 2.7" Thick
- For beams set at 16" & 24" spacing
- Lighter than plywood
- Eliminates clean up, disposal & safety issues associated with wood splinters
- Ergonomic
- Stackable



### 49527-10 | GlideLock®

5,400 lbs WLL (2,450 kg)

- Moveable securement bracket for double L-track
- Provides a sliding positive attachment point for flat hooks





# INTERIOR VAN SOLUTIONS

## Logistic Straps for E & A Track

### Ratchet Buckle | Spring End Fitting

1,333 lbs WLL (605 kg)

- 48" Fixed end
- Low profile ratchet
- Bulk packaged
- Color coded by length

Part Number	Length (Feet)	Color
48672-13	12'	Yellow
48672-14	16'	Gray
48672-15	20'	Blue

2" Standard High Capacity Webbing



### Cam Buckle | Spring End Fitting

833 lbs WLL (378 kg)

- 48" Fixed end
- Bulk packaged
- Color coded by length

Part Number	Length (Feet)	Color
40602-17	12'	Yellow
40602-18	16'	Gray
40602-19	20'	Blue

2" Standard High Capacity Webbing



## Logistic Track

### Series E-Track

- Available in horizontal & vertical styles
- Designed to be screwed or bolted to floors, sidewalls or wood studs
- Provides convenient anchoring slots to secure cargo with Ancra logistic straps or create decking tiers with Ancra decking & shoring beams
- Made with 12-gauge steel
- Finished with a high quality powder coat, semi-gloss enamel or G90 hot dip galvanize for exceptional corrosion resistance

#### Horizontal



Gray Powder Coat  
10FT 48117-25-120.00  
5FT 48117-25-60.00



Black Powder Coat  
10FT 48117-32-120.00



Galvanized  
10FT 48117-21-120.00  
5FT 48117-21-60.00

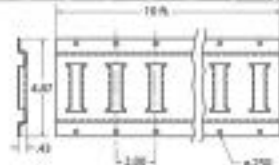

#### Vertical

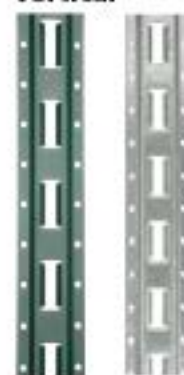

10FT Gray Powder Coat 40838-10  
10FT Galvanized 40838-11

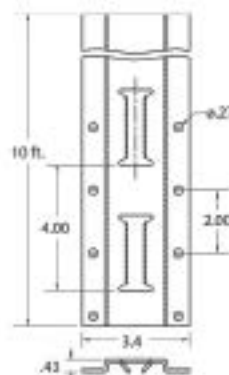

### Aircraft Style Aluminum O-Track

- Available in standard & beveled styles
- Designed to be screwed or bolted to floors, sidewalls or wood studs
- Works with single or double stud fittings
- Beveled style helps prevent catch point for cargo & footing
- Easy to remove debris from track with air hose



6FT Standard Profile 40467-33-72.00



6FT Beveled Profile 50193-30-72.00

## Decking & Shoring Beams for E & A Track

- Light weight aluminum helps maximize payload & resists corrosion
- Adjustable ranges available to fit most commercial trailer widths
- Designed to create decks to hold pallets or to prevent pallets from shifting
- Ancra patented flat latch eliminates damaged triggers & is easier to release, even when wearing gloves

Part Number	Adjustable Range	Style	Decking WLL (lbs)	Shoring WLL (lbs)
43638-50	84.7" - 95.6"	Standard	2,200	2,200
43638-51	92.9" - 103.8"	Standard	2,200	2,200
49039-50	84.7" - 95.6"	Heavy Duty	3,000	2,500
49039-51	92.9" - 103.8"	Heavy Duty	3,000	2,500
49039-52	96" - 106.9"	Heavy Duty	3,000	2,500



PATENTED



# INTERIOR VAN SOLUTIONS

## Adjustable Cargo & Jack Bars

43782-15 | Cargo STA®, Aluminum

89.75" - 104.5"

- Pressure fit from wall to wall to help prevent cargo shift
- 4" x 4" Foot pads
- 8.95 Lbs



48407-10 | Cargo STA®, Galvanized Steel

89.75" - 104.5"

- 2" x 4" Foot pads
- 11.72 Lbs



49205-25 | Jack Bar, Galvanized Steel

85.00" - 104.00"

- Pressure fit from floor to ceiling to prevent cargo shift
- 4" x 4" Foot pads
- Quick release jack mechanism
- 16.2 Lbs

PATENTED



**CAUTION:** Due to variations in the trailer wall construction cargo bars do not have a working load limit.

## Driver Assist Products

Driver Assist Straps | 10902-11PK | Single Loop

10902-21 | Dual Loop

- 36" Strap with a reinforced 12" loop handle
- Connects to E & A-track



10924-10 | Trailer Door Limit Strap

800 lbs WLL (363 kg)

- Hooks are inserted into the lock tabs on each door before opening to limit the motion of the door
- 32" Length from hook to hook



10788-10 | Door Pull Strap Kit

500 lbs WLL (227 kg)

- Allows driver to close the roll-up door while standing on the ground
- Black wear sleeve protects the elastic section
- Installs into logistic post or E-track



50354-10 | Fifth Wheel Release

- 35" Length
- Chrome plated finish
- Welded steel construction



Door Pull Straps

- Galvanized steel clip
- Designed for pulling overhead & side doors



Part Number	Length (Inches)
49015-18	18"
49015-24	24"
49015-36	36"



# TRACK FITTINGS & ANCHORS

## Hardware - Bulk Bin Packaged

**XH8003-12PB** | 12/Box  
 12" O-Track - Beveled  
 1,333 lbs WLL (600 kg)  
 • Great for floor mounting



**XH8005-12PB** | 12/Box  
 Single Stud O-Track Fitting  
 1,333 lbs WLL (600 kg)  
 • Designed for standard  
 & beveled logistic track



**XH8006-12PB** | 12/Box  
 Double Stud O-Track Fitting  
 2,000 lbs WLL (909 kg)  
 • Designed for standard  
 & beveled logistic track



**XH8022-12PB** | 12/Box  
 HD E-Track Fitting w/O-Ring  
 2,000 lbs WLL (909 kg)  
 • Makes E-track useable with standard  
 tie-down hooks  
 • Low profile



**XH8031-8PB** | 8/Box  
 5/8" D-Ring  
 5,000 lbs WLL (2,267 kg)  
 • Forged steel ring with bracket  
 • Surface mount weld-on design



**XH8030-8PB** | 8/Box  
 3/4" D-Ring  
 6,666 lbs WLL (3,023 kg)  
 • Forged steel ring with bracket  
 • Surface mount weld-on design



## D-Rings

**49896-10**  
 1/2" D-Ring  
 4,000 lbs WLL (1,814 kg)  
 • Forged steel ring with  
 bolt-on clip



**49896-11**  
 1/2" D-Ring  
 4,000 lbs WLL (1,814 kg)  
 • Forged steel ring with bracket  
 • Surface mount weld-on design



**49897-10**  
 5/8" D-Ring  
 6,300 lbs WLL (2,858 kg)  
 • Forged steel ring with bracket  
 • Surface mount weld-on design



**49898-10**  
 3/4" D-Ring  
 9,000 lbs WLL (4,082 kg)  
 • Forged steel ring with bracket  
 • Surface mount weld-on design



**49899-10**  
 1" D-Ring  
 15,600 lbs WLL (7,076 kg)  
 • Forged steel ring with bracket  
 • Surface mount weld-on design



**49899-11**  
 1" Bent D-Ring  
 15,600 lbs WLL (7,076 kg)  
 • Forged bent steel ring with bracket  
 • Surface mount weld-on design





# TRACK FITTINGS & ANCHORS

## E-Track Tie-Off Fittings - Bulk

**47772-12**  
2" HD E-Track Fitting w/O-Ring  
1,833 lbs WLL (833 kg)

- Makes E-track useable with standard tie-down hooks
- Low profile



**50115-10**  
HD E-Track Fitting w/O-Ring  
2,000 lbs WLL (909 kg)

- Makes E-track useable with standard tie-down hooks
- Low profile



**50115-11**  
HD E-Track Fitting w/D-Ring  
2,000 lbs WLL (909 kg)

- Makes E-track useable with standard tie-down hooks
- Low profile



**40386-11**  
5" Rope Tie Off Strap  
1,000 lbs WLL (454 kg)

- Spring actuated fitting



**41409-13**  
2" 3 Piece Fitting  
1,000 lbs WLL (454 kg)

- Replacement end for 2" web straps



**47608-21**  
Series E & A Track Spring Fitting

- Replacement end for 2" web straps
- 1,333 lbs WLL in 12 gauge track
- 1,500 lbs WLL in 11 gauge track



## O-Track Tie-Off Fittings - Bulk

**50112-10**  
Single Stud O-Track Fitting  
1,333 lbs WLL (600 kg)

- Aluminum retainer
- Blue



**50112-20**  
Single Stud O-Track Fitting  
1,333 lbs WLL (600 kg)

- Cast retainer
- Blue



**50362-11**  
Double Stud O-Track Fitting  
1,666 lbs WLL (756 kg)

- Designed for standard & beveled logistic track



## Pan Tie-Off Fittings

**45545-15**  
Pan Fitting  
530 lbs WLL (240 kg)

- Galvanized steel
- Low profile surface mount, bolt-on



**45849-15**  
Recessed Pan Fitting  
1,666 lbs WLL (757 kg)

- Low profile, recessed mount, bolt-on



**40921-10** | Standard Beam Socket  
Make your own shoring beam. For use with standard commercial grade 2" x 6" structural lumber.  
**PLEASE NOTE:** The working load limit of lumber varies widely.





# CHAIN FITTINGS

## Screw Pin Shackles

### Galvanized

- Screw pin style
- Individually polybagged with UPC
- Retail pack quantity 1

Part Number	Size (Inches)	Working Load Limit (lbs)	Working Load Limit (kg)
50013-31	5/16"	1,500	681
50013-38	3/8"	2,000	900
50013-44	7/16"	3,000	1,362
50013-50	1/2"	4,000	1,816
50013-63	5/8"	6,500	2,951
50013-75	3/4"	9,500	4,313
50013-88	7/8"	11,300	5,125
50013-100	1"	17,000	7,710



Part Number	A	B	C	D	E	F	G
50013-31	.81	2.25	1.25	.53	3/8	.31	1.00
50013-38	.94	2.61	1.44	.66	7/16	.38	1.13
50013-44	1.06	3.01	1.69	.72	1/2	.44	1.25
50013-50	1.19	3.34	1.88	.81	5/8	.50	1.38
50013-63	1.50	4.04	2.41	1.06	3/4	.63	1.88
50013-75	1.75	5.04	2.84	1.25	7/8	.75	2.13
50013-88	2.00	5.86	3.31	1.44	1.00	.75	2.38
50013-100	2.31	6.63	3.75	1.69	1.13	.75	2.63

## Clevis Pin Shackles

### Galvanized

- Clevis pin style
- Individually polybagged with UPC
- Retail pack quantity 1

Part Number	Size (Inches)	Working Load Limit (lbs)	Working Load Limit (kg)
50014-50	1/2"	4,000	1,816
50014-63	5/8"	6,500	2,951

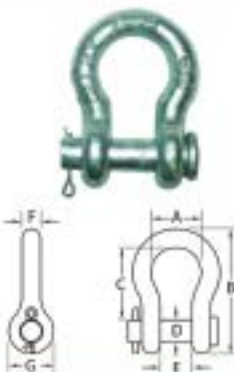

Part Number	A	B	C	D	E	F	G
50014-50	1.19	3.39	1.88	5/8	.81	.50	1.38
50014-63	1.50	4.17	2.41	3/4	1.06	.63	1.88

## Clevis Pin Replacements

High strength steel replacement clevis pins are designed to meet the strength requirements of Grade 70 hooks & their heads are marked G7 or 70.

**50412-100** Packaged Kit includes one zinc plated clevis pin & cotter pin for 5/16 Grade 70 chain hook. Weight: .17 lbs / .07 kg

**50412-102** Packaged Kit includes one zinc plated clevis pin & cotter pin for 3/8 Grade 70 chain hook. Weight: .22 lbs / .09 kg

**50412-103** Packaged Kit includes one zinc plated clevis pin & cotter pin for 1/2 Grade 70 chain hook. Weight: .23 lbs / .10 kg

Note: Anra does not offer galvanized replacement pins. Zinc-plated steel replacement pins can be used with galvanized steel clevis hooks without concern for bimetallic corrosion. However, the sacrificial zinc plated layer may wear slightly faster than the galvanized layer.

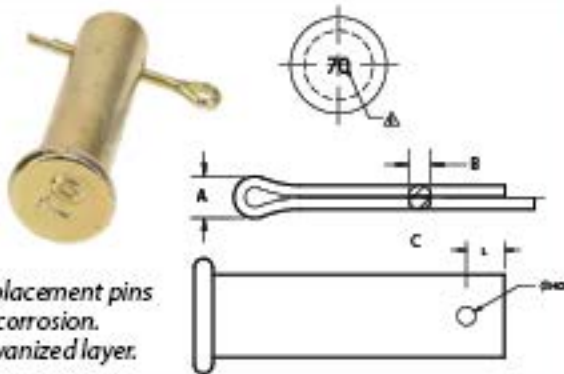

## Quick Links

### Zinc Plated Clear Chromate

- Individually polybagged with UPC
- Retail pack quantity 1

Part Number	Size (Inches)	Working Load Limit (lbs)	Working Load Limit (kg)
50016-25	1/4"	880	399
50016-31	5/16"	1,760	799
50016-38	3/8"	2,200	998

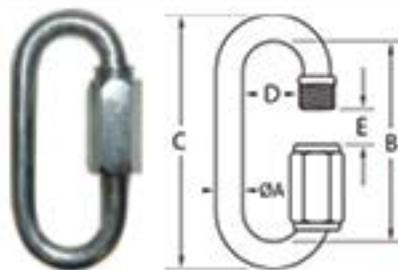

Part Number	A	B	C	D	E
50016-25	.235	1.85	2.31	.51	.32
50016-31	.313	2.32	2.95	.65	.41
50016-38	.350	2.54	3.22	.67	.43



# HOOKS, BUCKLES & WEBBING





# HOOKS

**40316-12**

**1" Narrow Wire Hook**

- 166 lbs WLL (75 kg)
- Heat treated
- Corrosion resistant plating

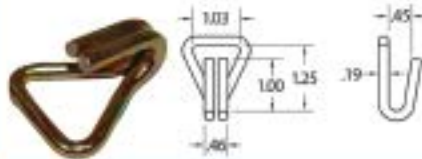

**40024-10**

**1" Narrow Wire Hook**

- 1,000 lbs WLL (454 kg)
- Heat treated
- Corrosion resistant plating

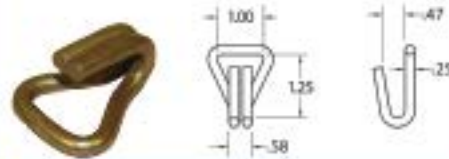

**43120-19**

**1-3/4" Narrow Wire Hook**

- 500 lbs WLL (227 kg)
- Heat treated
- Corrosion resistant plating

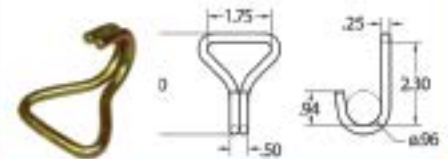

**43120-11**

**2" Narrow Wire Hook**

- 1,666 lbs WLL (757 kg)
- Heat treated
- Corrosion resistant plating



**43120-13**

**2" Narrow Wire Hook**

- 3,333 lbs WLL (1,515 kg)
- Heat treated
- Corrosion resistant plating

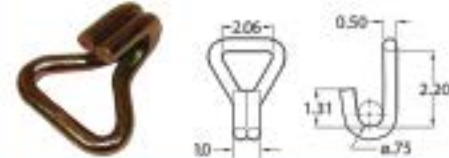

**43120-20**

**3" Narrow Wire Hook**

- 7,333 lbs WLL (3,333 kg)
- Heat treated
- Corrosion resistant plating



**40024-12**

**2" Narrow Wire Hook**

- 833 lbs WLL (378 kg)
- Heat treated
- Corrosion resistant plating



**40023-12**

**2" Wide Wire Hook**

- 833 lbs WLL (378 kg)
- Heat treated
- Corrosion resistant plating



**40891-18**

**2" Flat Hook**

- 3,333 lbs WLL (1,515 kg)
- Heat treated
- Corrosion resistant plating

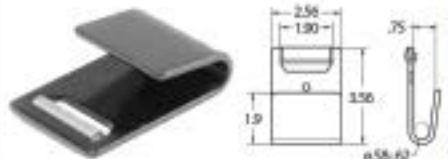

**41313-13**

**1" Vinyl S-Hook**

- 400 lbs WLL (181 kg)
- Heat treated



**41313-19**

**1" Vinyl S-Hook**

- 600 lbs WLL (272 kg)
- Heat treated



**43546-10**

**1" Gutter Hook**

- 250 lbs WLL (113 kg)
- Heat treated
- Corrosion resistant plating



**40065-10**

**1" Plated Flat Hook**

- 333 lbs WLL (151 kg)
- Heat treated
- Corrosion resistant plating



**40065-12**

**1" Vinyl Flat Hook**

- 333 lbs WLL (151 kg)
- Heat treated
- Corrosion resistant plating

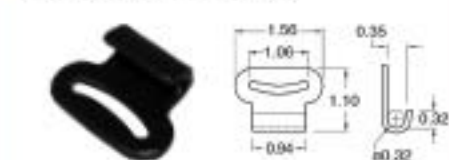

**40044-10**

**1" Flat Hook w/Keeper**

- 1,166 lbs WLL (530 kg)
- Heat treated
- Corrosion resistant plating





# HOOKS

**45515-10**

**RTJ Cluster Hook**

- 3,900 lbs WLL (1,770 kg)
- Heat treated

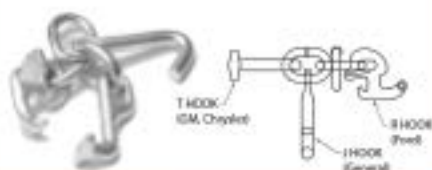

**49914-10**

**Swivel J Idler Hook**

- 3,333 lbs WLL (1,515 kg)
- Heat treated with gold zinc finish

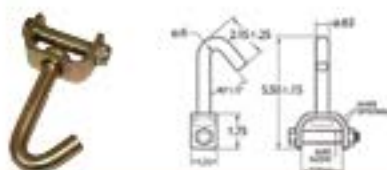

**49914-11**

**Swivel J Idler Hook**

- 3,333 lbs WLL (1,515 kg)
- Heat treated with gold zinc finish
- Low profile

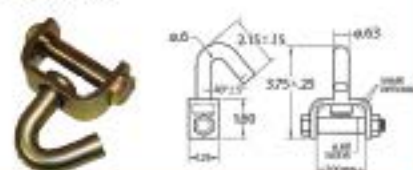

**43365-12**

**Grab Hook Assembly**

- 5,400 lbs WLL (2,450 kg)
- Heat treated
- Gold zinc plated finish



**48968-11**

**2" Roll-Off Container Hook**

- 5,400 lbs WLL (2,450 kg)
- Heat treated
- Corrosion resistant plating

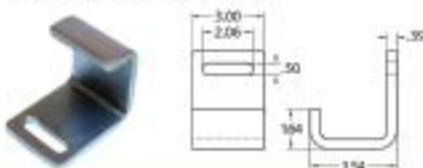

**49770-10**

**4" HD Waste Container J-Hook**

- 5,100 lbs WLL (2,313 kg)
- Heat treated
- Corrosion resistant plating



**40084-14**

**2" Snap Hook**

- 2,100 lbs WLL (953 kg)
- Rust resistant



**43044-10**

**2" Snap Hook**

- 1,666 lbs WLL (757 kg)
- Rust resistant



**40758-11**

**2" Twisted Snap Hook**

- 3,333 lbs WLL (1,515 kg)
- Satin black finish

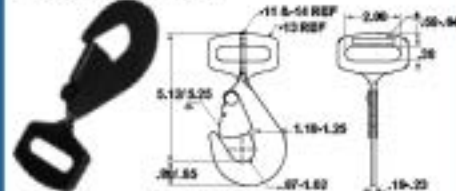

**40758-13**

**2" Snap Hook**

- 3,333 lbs WLL (1,515 kg)
- Satin black finish

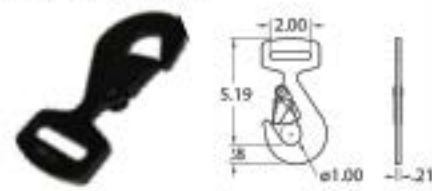

**40025-10**

**1" D-Ring**

- 1,666 lbs WLL (757 kg)
- Rust resistant



**40025-12**

**2" D-Ring**

- 1,666 lbs WLL (757 kg)
- Rust resistant



**40978-11**

**2" Delta Ring**

- 3,333 lbs WLL (1,515 kg)
- Rust resistant



**41631-12**

**4" Delta Ring**

- 6,666 lbs WLL (3,030 kg)
- Rust resistant



Ankra designs & manufactures a full spectrum of restraints & hardware to meet your wide ranging needs. Our specialty items represent our ongoing mission to provide the right solutions for a changing industry. If you can't find a specific product in this catalog, or if you have a particular requirement that calls for a unique solution, give us a call.

# BUCKLES

## Ratchet Buckles

**43320-32**  
**1" Ratchet Buckle**  
 1,466 lbs WLL (666 kg)



**48770-10**  
**1" Ratchet Buckle**  
 500 lbs WLL (227 kg)  
 • Low profile  
 • Black powder coat



**44232-10**  
**1" Ratchet Buckle**  
 400 lbs WLL (181 kg)



**41808-14**  
**1-3/4" Ratchet Buckle**  
 2,000 lbs WLL (908 kg)  
 • Hook end

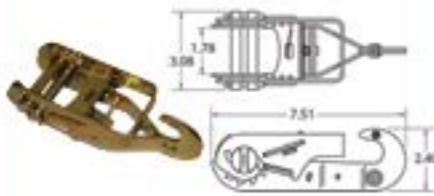

**49715-10**  
**2" Ratchet Buckle**  
 1,500 lbs WLL (680 kg)  
 • Long wide handle torque limiting



**44258-13**  
**2" Ratchet Buckle**  
 1,500 lbs WLL (680 kg)  
 • Low profile



**44627-11**  
**2" Ratchet Buckle**  
 3,333 lbs WLL (1,515 kg)  
 • Standard handle



**44587-10**  
**2" Ratchet Buckle**  
 3,666 lbs WLL (1,666 kg)  
 • Long wide handle



**50037-10**  
**2" Ratchet Buckle w/Keeper**  
 3,666 lbs WLL (1,666 kg)  
 • Long wide handle

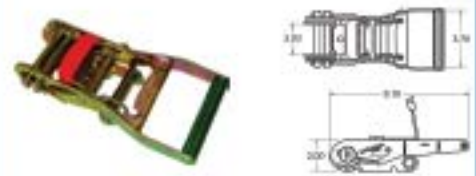

**47105-11**  
**2" Ratchet Buckle**  
 3,666 lbs WLL (1,666 kg)  
 • Short wide handle



**48965-10**  
**3" Ratchet Buckle**  
 7,333 lbs WLL (3,333 kg)  
 • Long handle



**49349-10**  
**4" Ratchet Buckle**  
 8,000 lbs WLL (3,636 kg)  
 • Standard handle





# BUCKLES & WEBBING

## Cam & Specialty Buckles

**41030-12**  
1" Cam Buckle  
166 lbs WLL (75 kg)



**42195-11**  
1" Cam Buckle  
500 lbs WLL (227 kg)



**40880-22**  
1" Cam Buckle  
600 lbs WLL (272 kg)



**40880-15**  
2" Cam Buckle  
833 lbs WLL (378 kg)



**41645-10**  
Roller Buckle  
500 lbs WLL (227 kg)

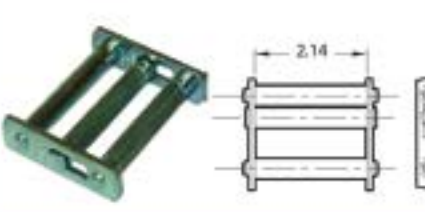

**44639-12**  
1-3/4" Overcenter Buckle  
1,666 lbs WLL (757 kg)  
• One piece steel frame



## Webbing

Along with exceptional quality, Ancra's broad line of webbing gives you a range of choices to match your application. Custom made according to our strict specifications, Ancra webbing is treated for extra strength and durability, offering additional flexibility and ease of use.



Width		Breaking Strength Capacity		Type	Standard Color	Part Number
in.	mm.	lbs.	kg.			
1.00	25	4,500	2,045	Nylon	Red	41820-10-RL
					Blue	41820-14-RL
					Black	41820-15-RL
2.00	50	6,000	2,727	Polyester	Yellow	47200-61-BULK-CUT
					Gray	47200-60-BULK-CUT
					Blue	47200-62-BULK-CUT
2.00	50	6,000	2,727	Polyester	Red	47200-64-BULK-CUT
					Blue	47200-62-BULK-CUT
2.00	50	12,000	5,454	Polyester, Latex Treated	Blue	41632-26-BULK-CUT
					Yellow	41632-31-BULK-CUT
					Red	41632-19-BULK-CUT
3.00	75	18,000	8,181	Polyester, Latex Treated	Yellow	41632-17-BULK-CUT
					Blue	41632-24-BULK-CUT
4.00	100	20,000	9,090	Polyester, Latex Treated	Gray	43797-18-BULK-CUT
					Blue	43797-19-BULK-CUT
					Red	43797-23-BULK-CUT
					Yellow	43797-36-RL
					Green	43797-34-BULK-CUT

Webbing will have a longer life if stored in a dry, dark location. Continuous exposure to ultra-violet light can degrade the strength of synthetic webbing.

# SAFETY TIPS



## TIE-DOWN TIPS

From the Web Sling and Tie Down Association

To help prevent unrated straps, Ancra uses high-quality, tear and fade-resistant, reinforced vinyl WLL labels on all flatbed tie downs.

- ▶ The angle from the horizontal (tie-down to trailer deck) has an enormous influence on load securement.
- ▶ If the angle is 90 degrees, the effective downward pressure is 100% of the tie-down tension.
- ▶ If the angle is 60 degrees, the effective downward pressure is reduced to 87% of the tie-down tension.
- ▶ If the angle is 45 degrees, the effective downward pressure is reduced to 71% of the tie-down tension.
- ▶ If the angle is 30 degrees, the effective downward pressure is reduced to 50% of the tie-down tension.

For more information about the Recommended Standard for Tie-Downs, contact WSTDA. [www.wstda.com](http://www.wstda.com)

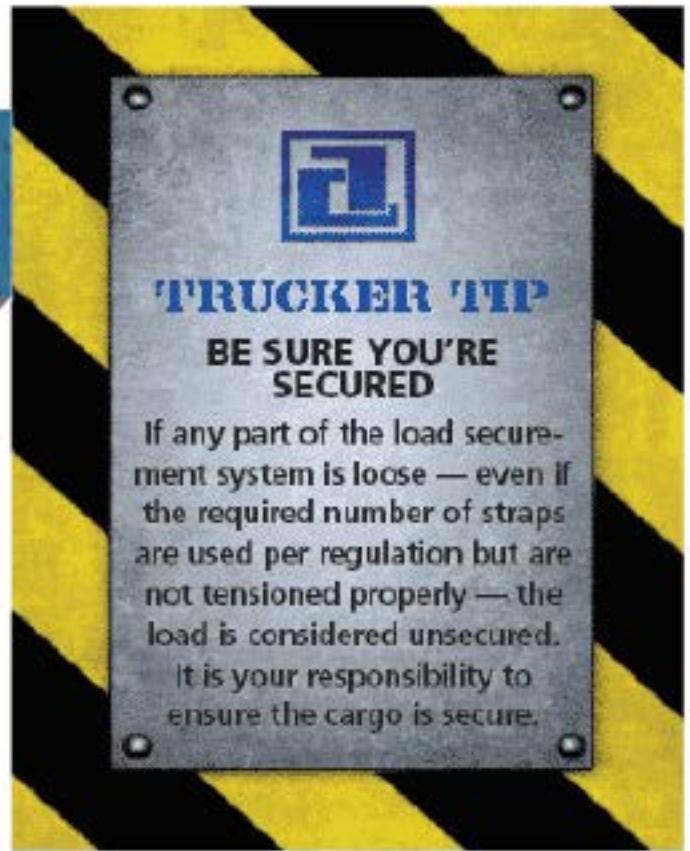

## Ancra Helps Keep You in Compliance with the Law

*Ancra's mobile tie-down-calculator app is available at no cost.*



### APP FEATURES

- ✓ Standard or metric options available
- ✓ Ability to enter custom article length
- ✓ Ability to enter Working Load Limit of Strap. Stores custom entry for future use!
- ✓ Ability to enter custom article weight
- ✓ Regulated Commodity Types listed with convenient web links to the FMCSA website for more information.

**Works with IOS and Android mobile devices**

Available on the  
**App Store**

GET IT ON  
**Google play**















# SAFETY FLAGS & BANNERS



**OVERSIZ**

# FLAGS & BANNERS

## Flags

<p><b>49893-10   Fluorescent Red</b>  <b>18<sup>IN</sup> x 18<sup>IN</sup></b>  <ul style="list-style-type: none"> <li>• Heavy duty mesh</li> <li>• Wooden dowel</li> </ul> </p>	<p><b>49893-11   Fluorescent Red</b>  <b>18<sup>IN</sup> x 18<sup>IN</sup></b>  <ul style="list-style-type: none"> <li>• Cotton</li> <li>• Steel wire rod w/loop</li> </ul> </p>	<p><b>49893-12   Fluorescent Red</b>  <b>18<sup>IN</sup> x 18<sup>IN</sup></b>  <ul style="list-style-type: none"> <li>• Heavy duty mesh</li> <li>• 2 Brass grommets</li> </ul> </p>
<p><b>49893-13   Fluorescent Orange</b>  <b>18<sup>IN</sup> x 18<sup>IN</sup></b>  <ul style="list-style-type: none"> <li>• Heavy duty mesh</li> <li>• Wooden dowel</li> </ul> </p>	<p><b>49893-14   Fluorescent Orange</b>  <b>18<sup>IN</sup> x 18<sup>IN</sup></b>  <ul style="list-style-type: none"> <li>• Heavy duty mesh</li> <li>• 2 Brass grommets</li> </ul> </p>	<p><b>49893-15   Fluorescent Red</b>  <b>18<sup>IN</sup> x 18<sup>IN</sup></b>  <ul style="list-style-type: none"> <li>• Cotton</li> <li>• Wooden dowel</li> </ul> </p>
<p><b>49893-16   Fluorescent Red</b>  <b>18<sup>IN</sup> x 18<sup>IN</sup></b>  <ul style="list-style-type: none"> <li>• Jersey mesh</li> <li>• Wooden dowel</li> </ul> </p>	<p><b>49893-17   Fluorescent Red</b>  <b>18<sup>IN</sup> x 18<sup>IN</sup></b>  <ul style="list-style-type: none"> <li>• Jersey mesh</li> <li>• Steel wire rod w/loop</li> </ul> </p>	<p><b>49893-18   Fluorescent Orange</b>  <b>18<sup>IN</sup> x 18<sup>IN</sup></b>  <ul style="list-style-type: none"> <li>• Heavy duty mesh</li> <li>• Steel wire rod w/loop</li> </ul> </p>
<p><b>49893-19   Fluorescent Orange</b>  <b>18<sup>IN</sup> x 18<sup>IN</sup></b>  <ul style="list-style-type: none"> <li>• Jersey mesh</li> <li>• Steel wire rod w/loop</li> </ul> </p>	<p><b>49893-20   Fluorescent Orange</b>  <b>18<sup>IN</sup> x 18<sup>IN</sup></b>  <ul style="list-style-type: none"> <li>• Cotton</li> <li>• 2 Brass grommets</li> </ul> </p>	<p><b>50430-10   Magnetic Flag Holder</b>  <ul style="list-style-type: none"> <li>• 2.3" Diameter</li> <li>• Ceramic magnet</li> <li>• Center screw &amp; wing nut for attachment</li> </ul> </p>
		<p>All Flags and Banners meet FMCSA 393.87 Standards</p>



# FLAGS & BANNERS

## Banners

49894-12 | 2-Sided

14" x 72"

- Wide Load/Oversize Load
- Yellow vinyl
- Grommets & 44" ropes

**WIDE LOAD  
OVERSIZE LOAD**

49894-10 | 2-Sided

18" x 84"

- Wide Load/Oversize Load
- Yellow vinyl
- Grommets & 44" ropes

**WIDE LOAD  
OVERSIZE LOAD**

49894-11 | 2-Sided

18" x 84"

- Wide Load/Oversize Load
- Yellow vinyl
- Sewn-in ropes

**WIDE LOAD  
OVERSIZE LOAD**

49894-13 | Single Sided

18" x 84"

- Oversize Load
- Yellow polyester mesh
- Grommets & 44" ropes

MESH  
CONSTRUCTION

**OVERSIZE LOAD**

49894-14 | Single Sided

18" x 84"

- Wide Load
- Yellow polyester mesh
- Grommets & 44" ropes

MESH  
CONSTRUCTION

**WIDE LOAD**

49894-15 | 2-Sided

18" x 84"

- Wide Load/Oversize Load
- Yellow vinyl
- Sewn-in bungee cords

**WIDE LOAD  
OVERSIZE LOAD**

## Canada D Banners

49895-10

12" x 96"

- Vinyl
- 10 Grommets

49895-11

12" x 96"

- Reflective
- 10 Grommets

49895-12

18" x 96"

- Reflective
- 10 Grommets

49895-13

18" x 96"

- Reflective
- Reverse Side: Oversize Load
- 10 Grommets



## Roadside Safety

50434-10 | Triangle Warning Kit  
3 Collapsible Reflective Triangles

- Comes with durable red plastic case
- Certified by AMECA
- In compliance with FMCSA standards
- DOT certified



# MERCHANDISING SUPPORT

## Planograms

*We can help.*

*Whether you are just getting started or you need to redesign your entire program, we can assist by providing suggested planograms geared for your business. Simply contact your Ancra sales representative or Customer Service department to get the process started.*



## Package Styles

**Bulk**



**Bin Display**



**Shrink Wrap**



**I-Pack**



**Blister**



**Clamshell**



**Box**



10R3-30	Door Pull Strap	37	20-EM536	Sling, Endless	9	41631-12	Delta Ring	43	43638-51	Beam	36
10R32-11PK	Driver Assist Strap	37	20-EM537	Sling, Endless	9	41632-17-Bulk-Cut	Webbing	45	43782-15	Cargo Bar	37
10R32-21	Driver Assist Strap	37	20-EM538	Sling, Endless	9	41632-19-Bulk-Cut	Webbing	45	43795-10-27	Winch Strap, 4"	29
10R34-30	Tie-In Door Strap	37	20-EM539	Sling, Endless	9	41632-24-Bulk-Cut	Webbing	45	43795-10-30	Winch Strap, 4"	29
10R36-56	Tie-Down, Contractor Grade	17	214-306P	Winch Strap, 4"	29	41632-26-Bulk-Cut	Webbing	45	43795-10-35	Winch Strap, 4"	29
10R36-12	Tie-Down, Contractor Grade	17	30K21-8K	Acle Strap	20	41632-31-Bulk-Cut	Webbing	45	43795-10-40	Winch Strap, 4"	29
10R36-16	Tie-Down, Contractor Grade	17	30K21-8L	Acle Strap	20	41645-10	Roller Buckle	45	43795-10-50	Winch Strap, 4"	29
10R36-16J	Tie-Down, Contractor Grade	17	30K21-8D	Acle Strap	20	41669-10-27	Winch Strap, 2"	29	43795-10-60	Winch Strap, 4"	29
10R36-20	Tie-Down, Contractor Grade	17	30K33-8K	Acle Strap	20	41669-10-30	Winch Strap, 2"	29	43795-11-27	Winch Strap, 4"	29
20-EE1-9001K3	Sling, Eye-to-Eye	8	30K33-8L	Acle Strap	20	41669-11-27	Winch Strap, 2"	29	43795-11-30	Winch Strap, 4"	29
20-EE1-9001K4	Sling, Eye-to-Eye	8	30K33-8D	Acle Strap	20	41669-11-30	Winch Strap, 2"	29	43795-11-35	Winch Strap, 4"	29
20-EE1-9001K6	Sling, Eye-to-Eye	8	30K35	Tie Bonnet	20	41669-13-27	Winch Strap, 2"	29	43795-11-40	Winch Strap, 4"	29
20-EE1-9001K10	Sling, Eye-to-Eye	8	30K35-8L	Tie Bonnet	20	41669-13-30	Winch Strap, 2"	29	43795-11-50	Winch Strap, 4"	29
20-EE1-9002K3	Sling, Eye-to-Eye	8	30K35-8C-8K	Tie Bonnet	20	41669-40-27	Winch Strap, 2"	30	43795-13-30	Winch Strap, 4"	29
20-EE1-9002K4	Sling, Eye-to-Eye	8	30K35-8C-8L	Tie Bonnet	20	41669-40-30	Winch Strap, 2"	30	43795-13-45	Winch Strap, 4"	29
20-EE1-9002K6	Sling, Eye-to-Eye	8	30K35-8C-8D	Tie Bonnet	20	41669-42-30	Winch Strap, 2"	30	43795-13-65	Winch Strap, 4"	29
20-EE1-9002K10	Sling, Eye-to-Eye	8	30K35-8C-8L	Tie Bonnet	20	41669-43-30	Winch Strap, 2"	30	43795-13-75	Winch Strap, 4"	29
20-EE1-9002K12	Sling, Eye-to-Eye	8	30K7-8K	Tie Bonnet	20	41669-44-30	Winch Strap, 2"	30	43795-14-27	Winch Strap, 4"	29
20-EE1-9002K14	Sling, Eye-to-Eye	8	30K7-8L	Tie Bonnet	20	41669-44-30	Winch Strap, 2"	30	43795-14-30	Winch Strap, 4"	29
20-EE2-9001K4	Sling, Eye-to-Eye	8	30K7-8D	Tie Bonnet	20	41660-10-27	Winch Strap, 3"	29	43795-15-27	Winch Strap, 4"	29
20-EE2-9001K8	Sling, Eye-to-Eye	8	30K7-8L	Tie Bonnet	20	41660-10-30	Winch Strap, 3"	29	43795-15-30	Winch Strap, 4"	29
20-EE2-9002K3	Sling, Eye-to-Eye	8	30K7-8L	Tie Bonnet	20	41660-18-30	Winch Strap, 3"	29	43795-15-40	Winch Strap, 4"	29
20-EE2-9002K4	Sling, Eye-to-Eye	8	30K7-8L	Tie Bonnet	20	41806-14	Batchet Buckle	44	43795-19-30	Winch Strap, 4"	29
20-EE2-9002K6	Sling, Eye-to-Eye	8	30K7-8L	Tie Bonnet	20	41820-10-8L	Webbing	45	43795-40-30	Winch Strap, 4"	29
20-EE2-9002K8	Sling, Eye-to-Eye	8	30K7-8L	Tie Bonnet	20	41820-14-8L	Webbing	45	43795-60-30	Winch Strap, 4"	29
20-EE2-9002K10	Sling, Eye-to-Eye	8	4003-12	Wire Hook	42	41820-15-8L	Webbing	45	43795-90-27	Winch Strap, 4"	30
20-EE2-9002K12	Sling, Eye-to-Eye	8	4004-10	Wire Hook	42	42068-12	Corner Protector	28	43795-90-30	Winch Strap, 4"	30
20-EE2-9002K16	Sling, Eye-to-Eye	8	4004-12	Wire Hook	42	42185-11	Cam Buckle	45	43795-90-40	Winch Strap, 4"	30
20-EE2-9002K20	Sling, Eye-to-Eye	8	4005-10	D-Ring	43	42313-10	Winch Bar	35	43795-91-27	Winch Strap, 4"	30
20-EE2-9002K24	Sling, Eye-to-Eye	8	4005-12	D-Ring	43	42313-12	Winch Bar	35	43795-91-30	Winch Strap, 4"	30
20-EE2-9002K30	Sling, Eye-to-Eye	8	4004-10	Flat Hook	42	42313-17	Winch Bar	35	43795-91-40	Winch Strap, 4"	30
20-EE2-9002K30	Sling, Eye-to-Eye	8	4005-10	Flat Hook	42	42313-19	Winch Bar	35	43795-92-30	Winch Strap, 4"	30
20-EE2-9002K32	Sling, Eye-to-Eye	8	4005-12	Flat Hook	42	42357-11	Winch Track	34	43795-93-30	Winch Strap, 4"	30
20-EE2-9002K36	Sling, Eye-to-Eye	8	4004-14	Snap Hook	43	42357-12	Winch Track	34	43795-95-30	Winch Strap, 4"	30
20-EE2-9002K20	Sling, Eye-to-Eye	8	40316-12	Wire Hook	42	42357-21	Winch Track	34	43797-18-Bulk-Cut	Webbing	45
20-EE2-9004K6	Sling, Eye-to-Eye	8	40386-11	Track Pitting	39	43044-10	Snap Hook	43	43797-19-Bulk-Cut	Webbing	45
20-EE2-9004K8	Sling, Eye-to-Eye	8	40467-33-72.00	Track	36	43120-11	Wire Hook	42	43797-23-Bulk-Cut	Webbing	45
20-EE2-9004K10	Sling, Eye-to-Eye	8	40602-17	Logistic Strap	36	43120-13	Wire Hook	42	43797-36-8L	Webbing	45
20-EE2-9004K12	Sling, Eye-to-Eye	8	40602-18	Logistic Strap	36	43120-19	Wire Hook	42	43797-34-Bulk-Cut	Webbing	45
20-EE2-9004K16	Sling, Eye-to-Eye	8	40602-19	Logistic Strap	36	43120-20	Wire Hook	42	43798-10	Corner Protector	28
20-EE2-9004K20	Sling, Eye-to-Eye	8	40758-11	Snap Hook	43	43200-32	Batchet Buckle	44	44232-10	Batchet Buckle	44
20-EE2-9004K30	Sling, Eye-to-Eye	8	40758-13	Snap Hook	43	43265-12	Grab Hook	43	44258-13	Batchet Buckle	44
20-EM1K3	Sling, Endless	9	40838-10	Track	36	43488-20	Winch	32	44587-10	Batchet Buckle	44
20-EM1K4	Sling, Endless	9	40838-11	Track	36	43546-10	Cutter Hook	42	44627-11	Batchet Buckle	44
20-EM1K6	Sling, Endless	9	40890-15	Cam Buckle	45	43563-10	Winch	32	44639-12	Oversize Buckle	45
20-EM1K8	Sling, Endless	9	40890-22	Cam Buckle	45	43563-10-8W	Winch, Patcheting	34	45143-20	Becket Strap	20
20-EM1K10	Sling, Endless	9	40898-10	Tie-Down, Motorports	22	43564-127	Winch	32	45143-22	Becket Strap	20
20-EM1K12	Sling, Endless	9	40898-26	Tie-Down, Motorports	22	43564-147	Winch	32	45214-10	Soft Hook	22
20-EM2K3	Sling, Endless	9	40898-28	Tie-Down, Motorports	22	43564-167	Winch	32	45214-14	Soft Hook	22
20-EM2K4	Sling, Endless	9	40898-34	Tie-Down, Motorports	22	43565-127	Winch	32	45515-10	Cluser Hook	43
20-EM2K8	Sling, Endless	9	40899-10	Bolt-On Pitting Kit	22	43565-127-8W	Winch, Patcheting	34	45545-15	Pen Pitting	39
20-EM2K12	Sling, Endless	9	40891-18	Flat Hook	42	43565-137	Winch	32	45801-10	Web Winder	30
20-EM2K20	Sling, Endless	9	40921-10	Beam Socket	39	43565-14	Winch	32	45848-15	Pen Pitting	39
20-EM3K3	Sling, Endless	9	40978-11	Delta Ring	43	43565-157	Winch	32	45880-10	Transport Chain	25
20-EM3K4	Sling, Endless	9	40985-05-12	Web Protector	30	43565-157-8W	Winch, Patcheting	34	45880-11	Transport Chain	25
20-EM3K8	Sling, Endless	9	40985-05-8L	Web Protector	30	43565-157-KZ	Winch, Zinc	32	45880-12	Transport Chain	25
20-EM3K12	Sling, Endless	9	41020-12	Cam Buckle	45	43573-10	Winch	32	45880-13	Transport Chain	25
20-EM3K20	Sling, Endless	9	41313-13	S-Hook	42	43579-20	Winch	32	45881-10-16	Transport Chain	24
20-EM4K10	Sling, Endless	9	41313-19	S-Hook	42	43638-50	Beam	36			
20-EM4K16	Sling, Endless	9	41409-13	Track Pitting	39						
20-EM5K4	Sling, Endless	9	41516-11	Corner Protector	28						



# INDEX

45881-30-20	Transport Chain	24	45881-10-20	Transport Chain	24	49117-25-120.00	Track	36	49346-93-30	Tie-Down, Heavy Duty	15
45881-30-20-5P	Transport Chain	24	45881-10-20-5P	Transport Chain	24	49117-32-120.00	Track	36	49346-10	atchet Buckle	44
45881-30-25	Transport Chain	24	45881-10-25	Transport Chain	24	49407-10	Cargo Bar	37	49377-10	Corner Protector	28
45881-30-25-5P	Transport Chain	24	45881-10-25-5P	Transport Chain	24	49487-24	Tie-Down, Vehicle	21	49377-11	Corner Protector	28
45881-11-16	Transport Chain	24	45881-11-16	Transport Chain	24	49672-13	loglink Strap	36	49380-10	Tie-Down, Motorports	22
45881-11-16-5P	Transport Chain	24	45881-11-16-5P	Transport Chain	24	49672-14	loglink Strap	36	49380-11	Tie-Down, Motorports	22
45881-11-20	Transport Chain	24	45881-11-20	Transport Chain	24	49672-15	loglink Strap	36	49380-12	Tie-Down, Motorports	22
45881-11-20-5P	Transport Chain	24	45881-11-20-5P	Transport Chain	24	49770-10	Ratchet Buckle	44	49454-11	Rubber Rope Reel	5
45881-11-25	Transport Chain	24	45881-11-25	Transport Chain	24	49965-10	Ratchet Buckle	44	49454-13	Rubber Rope Reel	5
45881-11-25-5P	Transport Chain	24	45881-11-25-5P	Transport Chain	24	49968-11	Container Hook	43	49496-10	Tie-Down, Motorports	22
45881-13-20	Transport Chain	24	45881-13-20	Transport Chain	24	49967-20	Tie-Down, Heavy Duty	15	49496-11	Tie-Down, Motorports	22
45881-13-25	Transport Chain	24	45881-13-25	Transport Chain	24	49967-21	Tie-Down, Heavy Duty	15	49496-12	Tie-Down, Motorports	22
45943-30	Chain Binder	26	45943-30	Chain Binder	26	49967-24	Tie-Down, Heavy Duty	15	49526-10	Container Strap	30
45943-30HD	Chain Binder	26	45943-30HD	Chain Binder	26	49967-25	Tie-Down, Heavy Duty	15	49526-11	Container Strap	30
45943-11	Chain Binder	26	45943-11	Chain Binder	26	49967-28	Tie-Down, Heavy Duty	15	49526-90	Container Strap	30
45943-12	Chain Binder	26	45943-12	Chain Binder	26	49967-29	Tie-Down, Heavy Duty	15	49526-91	Container Strap	30
45943-13	Chain Binder	26	45943-13	Chain Binder	26	49967-40-27	Tie-Down, Heavy Duty	15	49527-10	SlideLock	35
45943-14	Chain Binder	26	45943-14	Chain Binder	26	49967-40-30	Tie-Down, Heavy Duty	15	49577-10	Corner Protector	28
45943-20	Chain Binder	26	45943-20	Chain Binder	26	49967-42-27	Tie-Down, Heavy Duty	15	49583-10	Floor Chain Tie-Down	35
45943-20HD	Chain Binder	26	45943-20HD	Chain Binder	26	49967-42-30	Tie-Down, Heavy Duty	15	49584-10	Corner Protector	28
45943-21	Chain Binder	26	45943-21	Chain Binder	26	49015-18	Door Pull Strap	37	49706-10	Winch	32
45943-22	Chain Binder	26	45943-22	Chain Binder	26	49015-24	Door Pull Strap	37	49715-10	Ratchet Buckle	44
45943-23	Chain Binder	26	45943-23	Chain Binder	26	49015-36	Door Pull Strap	37	49716-10	Porta Winch	34
45946-30	Hook, Clavis	25	45946-30	Hook, Clavis	25	49020-20	Tie-Down, Vehicle	21	49716-10-89H	Porta Winch, Ratcheting	34
45946-11	Hook, Clavis	25	45946-11	Hook, Clavis	25	49020-21	Tie-Down, Vehicle	21	49716-11	Porta Winch	34
45946-12	Hook, Clavis	25	45946-12	Hook, Clavis	25	49020-22	Tie-Down, Vehicle	21	49717-10	Porta Anchor	34
45946-13	Hook, Clavis	25	45946-13	Hook, Clavis	25	49020-23	Tie-Down, Vehicle	21	49723-10	Winch Cap	34
45982-30	Tie-Down, Heavy Duty	15	45982-30	Tie-Down, Heavy Duty	15	49023-21	Tie-Down, Vehicle	21	49756-10	Corner Protector	28
45982-11	Tie-Down, Heavy Duty	15	45982-11	Tie-Down, Heavy Duty	15	49023-22	Tie-Down, Vehicle	21	49770-10	Waste Container Hook	43
45982-11	Tie-Down, Heavy Duty	15	45982-15	Tie-Down, Heavy Duty	15	49038-50	Beam	36	49893-10	Flag	48
45982-19	Tie-Down, Heavy Duty	15	45982-19	Tie-Down, Heavy Duty	15	49038-51	Beam	36	49893-11	Flag	48
45982-34	Tie-Down, Heavy Duty	15	45982-34	Tie-Down, Heavy Duty	15	49038-52	Beam	36	49893-12	Flag	48
45982-36	Tie-Down, Heavy Duty	15	45982-36	Tie-Down, Heavy Duty	15	49205-25	Jack Bar	37	49893-13	Flag	48
45982-42	Tie-Down, Heavy Duty	15	45982-42	Tie-Down, Heavy Duty	15	49207-127	Winch	32	49893-14	Flag	48
45982-43	Tie-Down, Heavy Duty	15	45982-43	Tie-Down, Heavy Duty	15	49207-127-XL	Winch, Zinc	32	49893-15	Flag	48
45982-90-27	Tie-Down, Heavy Duty	15	45982-90-27	Tie-Down, Heavy Duty	15	49207-137	Winch	32	49893-16	Flag	48
45982-90-27-WK	Tie-Down, Heavy Duty	15	45982-90-27-WK	Tie-Down, Heavy Duty	15	49207-137-8W	Winch, Ratcheting	34	49893-17	Flag	48
45982-90-30	Tie-Down, Heavy Duty	15	45982-90-30	Tie-Down, Heavy Duty	15	49207-137-XL	Winch, Zinc	32	49893-18	Flag	48
45982-93-30	Tie-Down, Heavy Duty	15	45982-93-30	Tie-Down, Heavy Duty	15	49207-187	Winch	32	49893-19	Flag	48
45982-95-27	Tie-Down, Heavy Duty	15	45982-95-27	Tie-Down, Heavy Duty	15	49207-187-8W	Winch, Ratcheting	34	49893-20	Flag	48
45982-95-30	Tie-Down, Heavy Duty	15	45982-95-30	Tie-Down, Heavy Duty	15	49207-187-XL	Winch, Zinc	32	49894-10	Banner	49
47105-11	Ratchet Buckle	44	47105-11	Ratchet Buckle	44	49207-273	Winch	32	49894-11	Banner	49
47200-60-Bulk-Cut	Webbing	45	47200-60-Bulk-Cut	Webbing	45	49207-273-XL	Winch, Zinc	32	49894-12	Banner	49
47200-61-Bulk-Cut	Webbing	45	47200-61-Bulk-Cut	Webbing	45	49207-383-XL	Winch, Zinc	32	49894-13	Banner	49
47200-62-Bulk-Cut	Webbing	45	47200-62-Bulk-Cut	Webbing	45	49240-10-120	Winch Tack	34	49894-14	Banner	49
47200-63-Bulk-Cut	Webbing	45	47200-64-Bulk-Cut	Webbing	45	49344-12	Coil Rack	35	49894-15	Banner	49
47295-30	Tie-Down, Motorports	22	47295-30	Tie-Down, Motorports	22	49345-10	Floor Chain Tie-Down	35	49895-10	Banner	49
47439-30	Tie-Down, Motorports	22	47439-30	Tie-Down, Motorports	22	49346-10	Tie-Down, Heavy Duty	15	49895-11	Banner	49
47439-11	Tie-Down, Motorports	22	47439-11	Tie-Down, Motorports	22	49346-11	Tie-Down, Heavy Duty	15	49895-12	Banner	49
47608-21	Track Fitting	39	47608-21	Track Fitting	39	49346-12	Tie-Down, Heavy Duty	15	49895-13	Banner	49
47640-31	Winch, Lashing	34	47640-31	Winch, Lashing	34	49346-13	Tie-Down, Heavy Duty	15	49896-10	D-Ring	38
47772-12	Track Fitting	39	47772-12	Track Fitting	39	49346-14	Tie-Down, Heavy Duty	15	49896-11	D-Ring	38
47934-11	Wheel Dolly Strap	20	47934-11	Wheel Dolly Strap	20	49346-15	Tie-Down, Heavy Duty	15	49897-10	D-Ring	38
47935-11	Wheel Dolly Strap	20	47935-11	Wheel Dolly Strap	20	49346-20-27	Tie-Down, Heavy Duty	15	49898-10	D-Ring	38
48101-303	Winch	32	48101-303	Winch	32	49346-40-30	Tie-Down, Heavy Duty	15	49899-10	D-Ring	38
48101-143	Winch	32	48101-143	Winch	32	49346-41-27	Tie-Down, Heavy Duty	15	49899-11	D-Ring	38
48117-21-60.00	Track	36	48117-21-60.00	Track	36	49346-41-30	Tie-Down, Heavy Duty	15	49913-10	Tap Protector	28
48117-21-120.00	Track	36	48117-21-120.00	Track	36	49346-43-27	Tie-Down, Heavy Duty	15	49914-10	Swivel J-Hook	43
48177-25-60.00	Track	36	48177-25-60.00	Track	36				49914-11	Swivel J-Hook	43



49958-38-20	Transport Chain	24	50378-10-10	Transport Chain	24	95413	Bungee Cord, Standard	4	SL81	Tie-Down, Consumer	17
49958-38-20-5P	Transport Chain	24	50378-11-05-2	Transport Chain	24	95418	Bungee Cord, Standard	4	SL82	Tie-Down, Consumer	17
49970-102	Tie-Down, Motorsports	22	50391-10	Web Winder	30	95424	Bungee Cord, Standard	4	SL91	Tie-Down, Consumer	17
50013-31	Shackle	40	50409-10-1PK	Toe 'N Tie	30	95430	Bungee Cord, Standard	4	SL92	Tie-Down, Consumer	17
50013-38	Shackle	40	50412-100	Shackle	25, 40	95436	Bungee Cord, Standard	4	SL100	Tie-Down, Consumer	19
50013-44	Shackle	40	50412-102	Shackle	25, 40	95480	Bungee Mat	5	SL101	Tie-Down, Consumer	19
50013-50	Shackle	40	50412-103	Shackle	25, 40	95500-1	Bungee Cord, EZ Grip	4	SL102	Tie-Down, Consumer	19
50013-63	Shackle	40	50430-10	Flag Holder	48	95519-1	Bungee Cord, EZ Grip	4	SL148	Cambungee	4
50013-75	Shackle	40	50433-10	Winch Strap Beard	30	95524-1	Bungee Cord, EZ Grip	4	X8210-22P	Bungee Cord, Mini	4
50013-88	Shackle	40	50434-10	Triangle Warning Kit	49	95536-1	Bungee Cord, EZ Grip	4	XC108-2P	Tie-Down, Commercial	16
50013-100	Shackle	40	50451-21	Corner Protector Tool	28	95540-1	Bungee Cord, EZ Grip	4	X8003-1276	Track	38
50014-50	Shackle	40	50529-11-10-8X	Transport Chain	24	95548-1	Bungee Cord, EZ Grip	4	X8005-1276	Track Fitting	38
50014-63	Shackle	40	50739-10-05-2	Transport Chain	24	95600	Bungee Cord, Heavy Duty	4	X8006-1276	Track Fitting	38
50015-10	Winch Bar	35	52210C	Tarp Tie, Natural Rubber	6	95618	Bungee Cord, Heavy Duty	4	X8002-1276	Track Fitting	38
50015-20	Winch Bar	35	52215C	Tarp Tie, Natural Rubber	6	95624	Bungee Cord, Heavy Duty	4	X8003-898	D-Ring	38
50015-21	Winch Bar	35	52221C	Tarp Tie, Natural Rubber	6	95632	Bungee Cord, Heavy Duty	4	X8001-898	D-Ring	38
50016-25	Quick Link	40	52231C	Tarp Tie, Natural Rubber	6	95640	Bungee Cord, Heavy Duty	4	X8015-1P	Tie-Down, Commercial	16
50016-31	Quick Link	40	52241C	Tarp Tie, Natural Rubber	6	95648	Bungee Cord, Heavy Duty	4	X8015-4P	Tie-Down, Commercial	16
50016-38	Quick Link	40	52210GL	Tarp Tie, Goldline	6	95800	Tarp Tie	6	X8015-C1P	Tie-Down, Commercial	16
50019-10	Hook, Slip	25	52215GL	Tarp Tie, Goldline	6	95810	Tarp Tie	6	X8108-2P	Tie-Down, Commercial	16
50019-11	Hook, Slip	25	52221GL	Tarp Tie, Goldline	6	95815	Tarp Tie	6	X8115-C2P	Tie-Down, Commercial	16
50019-12	Hook, Slip	25	52231GL	Tarp Tie, Goldline	6	95821	Tarp Tie	6			
50019-13	Hook, Slip	25	52241GL	Tarp Tie, Goldline	6	95828	Tarp Tie, Adjustable	6			
50019-20	Hook, Slip	25	556	Tie-Down, Heavy Duty	14	95831	Tarp Tie	6			
50019-21	Hook, Slip	25	556-88KE	Tie-Down, Heavy Duty	14	95841	Tarp Tie	6			
50019-22	Hook, Slip	25	557	Tie-Down, Heavy Duty	15	96101	Web Puller	12			
50019-23	Hook, Slip	25	557-88KE	Tie-Down, Heavy Duty	15	96111	Cable Puller	12			
50025-10	Chain Binder	26	557-15	Tie-Down, Heavy Duty	15	96112	Cable Puller	12			
50037-10	Batchet Buckle	44	557-19WHK	Tie-Down, Heavy Duty	15	96114	Cable Puller	12			
50089-12	Corner Protector	28	557-40	Tie-Down, Heavy Duty	15	96121	Cable Puller	12			
50089-24	Corner Protector	28	557-40WHK	Tie-Down, Heavy Duty	15	96122	Cable Puller	12			
50089-36	Corner Protector	28	557-50	Tie-Down, Heavy Duty	15	96146	Gin Wheel	12			
50089-48	Corner Protector	28	557-50WHK	Tie-Down, Heavy Duty	15	96148	Wire Stretcher, Woven	12			
50092-10	Web Winder	30	577-60	Tie-Down, Heavy Duty	15	96149	Wire Stretcher, Fence	12			
500-85	Bully Strap	21	557-60WHK	Tie-Down, Heavy Duty	15	APS-15 192	Tie-Down, Commercial	16			
500-C6-8D	Tie-Down, Vehicle	21	800-215H	Recovery Strap	10	APS-3	Tie-Down, Commercial	16			
500-C8-8K	Tie-Down, Vehicle	21	800-225H	Recovery Strap	10	SL01	Tie-Down, Consumer	18			
500-C8-8L	Tie-Down, Vehicle	21	800-230	Recovery Strap	10	SL05	Tie-Down, Consumer	18			
500-C8-8D	Tie-Down, Vehicle	21	800-230	Recovery Strap	10	SL16	Tie-Down, Consumer	17			
500-C10-8K	Tie-Down, Vehicle	21	800-330	Recovery Strap	10	SL18	Tie-Down, Consumer	19			
500-825-8K	Tie-Down, Vehicle	21	800-430	Recovery Strap	10	SL24	Recovery Strap	10			
50078-8K	Tie-Down, Vehicle	21	800-630	Recovery Strap	10	SL27	Tie-Down, Consumer	17			
50106-11	Docking Board	35	95190	Tie-Down, Bulk Bin	18	SL30	Tie-Down, Consumer	18			
50112-10	Track Fitting	38	95181	Tie-Down, Bulk Bin	18	SL31	Recovery Strap	10			
50112-20	Track Fitting	38	95182	Tie-Down, Bulk Bin	18	SL32	Tie-Down, Consumer	19			
50115-10	Track Fitting	38	95183	Tie-Down, Bulk Bin	18	SL33	Bungee Cord, Mini	4			
50115-11	Track Fitting	38	95184	Tie-Down, Bulk Bin	18	SL38	Tie-Down, Consumer	18			
50117-10	Binder Lock	26	95185	Tie-Down, Bulk Bin	18	SL41	Bungee Assortment	5			
50140-10	Chain Binder	26	95186	Tie-Down, Bulk Bin	18	SL42	Bungee Assortment	5			
50140-11	Chain Binder	26	95187	Tie-Down, Bulk Bin	18	SL43	Canopy Tie	4			
50179-10	Tie-Down, Vehicle	21	95188	Tie-Down, Bulk Bin	19	SL46	Tie-Down, Consumer	18			
50179-11	Tie-Down, Vehicle	21	95189	Tie-Down, Bulk Bin	19	SL47	Tie-Down, Consumer	18			
50193-30-72.00	Track	36	95190	Tie-Down, Bulk Bin	19	SL48	Tie-Down, Consumer	18			
50254-10	Fifth Wheel Release	37	95191	Tie-Down, Bulk Bin	19	SL50	Bungee Mat	5			
50360-20	Chain Binder	26	95192	Tie-Down, Bulk Bin	19	SL51	Recovery Rope	10			
50360-21	Chain Binder	26	95193	Tie-Down, Bulk Bin	19	SL58	Tarp Tie Assortment	5			
50360-11	Track Fitting	38	95370	Tie-Down, Retractable	17	SL64	Bungee Assortment	5			
50364-38-10	Transport Chain	24	95372	Tie-Down, Retractable	17	SL66	Tie-Down, Consumer	17			
50364-38-20	Transport Chain	24	95400	Bungee Cord, Standard	4	SL69	Bungee Assortment	5			

Check out our YouTube Channel for dozens of videos on how not only use, but get the most of, your cargo control products.



Be sure to subscribe and turn on the alerts as we're constantly releasing new and exciting content!



# Your Single Source Cargo Control Supplier

- **INDUSTRY LEADING ENGINEERING** •
- **BEST-IN-CLASS QUALITY CONTROL** •
- **54 UNITED STATES PATENTS** •
- **800+ STOCKED PRODUCTS** •
- **OVER 50 YEARS IN BUSINESS** •

## INDUSTRY TRADE ASSOCIATIONS



**WARRANTY:** All Ancra Cargo, LLC products, unless otherwise indicated are warranted to be free from defect in material or workmanship for a period of six (6) months from date of shipment. During this period, Ancra Cargo, LLC will, at its option repair or replace without charge any products or part thereof found to be defective in material or workmanship. This warranty does not extend to any product which has been subject to misuse, abuse, negligence, accident, alteration or repair.

Defective products must be returned to Ancra Cargo, LLC within the above period, transportation prepaid. Ancra Cargo, LLC will bear the cost of return transportation. Contact Customer Service for details.

THIS WARRANTY IS IN LIEU OF ALL OTHER WARRANTIES EXPRESSED OR IMPLIED INCLUDING BUT NOT LIMITED TO ANY IMPLIED WARRANTY OF MERCHANTABILITY OR FITNESS FOR ANY PARTICULAR PURPOSE. IN NO EVENT WILL ANCRA CARGO, LLC BE LIABLE FOR SPECIAL, INDIRECT OR CONSEQUENTIAL DAMAGES OR LOSS OF VEHICLE, CARGO OR PROFITS.

### Ancra Cargo, LLC

1655 Worldwide Blvd., Hebron, KY 41048

### Consumer/Industrial Customer Service

Phone: (800) 626-8353 • Fax: (903) 962-7815

Email: [cicustomerservice@ancra.com](mailto:cicustomerservice@ancra.com)

[www.ancracargo-ci.com](http://www.ancracargo-ci.com)

### U.S. Heavy Duty Customer Service

Phone: (800) 233-5138 • Fax: (800) 347-2627

Email: [cargo-sales@ancra.com](mailto:cargo-sales@ancra.com)

[www.ancracargo.com](http://www.ancracargo.com)

### Ancra, Canada Customer Service

Phone: (866) 962-0055 • Fax: (866) 792-0058

Email: [ancracanada@ancra.com](mailto:ancracanada@ancra.com)

[www.ancracargo.com](http://www.ancracargo.com)

Scan this QR Code  
& connect with us  
on all our social  
media channels.

